



# VEHICLE-MOUNTED COMPUTERS

Configuration & Accessories Guide

VH10, VC70, VC80, VC80x, VC8300

# Zebra Vehicle Mounted Computers

## Product Family



**Windows 7/10**



**Windows CE**



**Android**



FOUR PLATFORMS... THREE FORM FACTORS...  
THE SAME ACCESSORIES, RUGGEDNESS, AND RELIABILITY

# Vehicle Mounted Computers

## Configuration & Accessories Guide

- The Zebra Technologies portfolio of accessories extends the capabilities of your **VH10**, **VC70**, **VC80**, **VC80x** or **VC8300**, and enables you to lower the cost of ownership of your Zebra mobile computer.
- This simple step-by-step guide is designed to assist you with the selection of your accessories based on your needs and use of the computers.



# VEHICLE-MOUNTED COMPUTERS

## Install Illustration

STEP	ACCESSORY	SLIDE
1	Power Supplies & Cables	6-14
2	Mounts	15-19
3	Scanners	20-22
4	Keyboards	23-25
5	Antennas	26-28
6	Voice	29-30
7	Miscellaneous	31-32
8	Service Parts	33-35



# Step 1: Power Supplies and Cables



## Choose from multiple installation cases

- Plug into an AC wall outlet
  - VH10, VC70, VC80, VC80x, VC8300 (Slide 6)
- Plug into the Vehicle's DC power
  - VC70 (Slides 7-9)
  - VH10, VC80, VC80x, VC8300 (Slides 10-14)

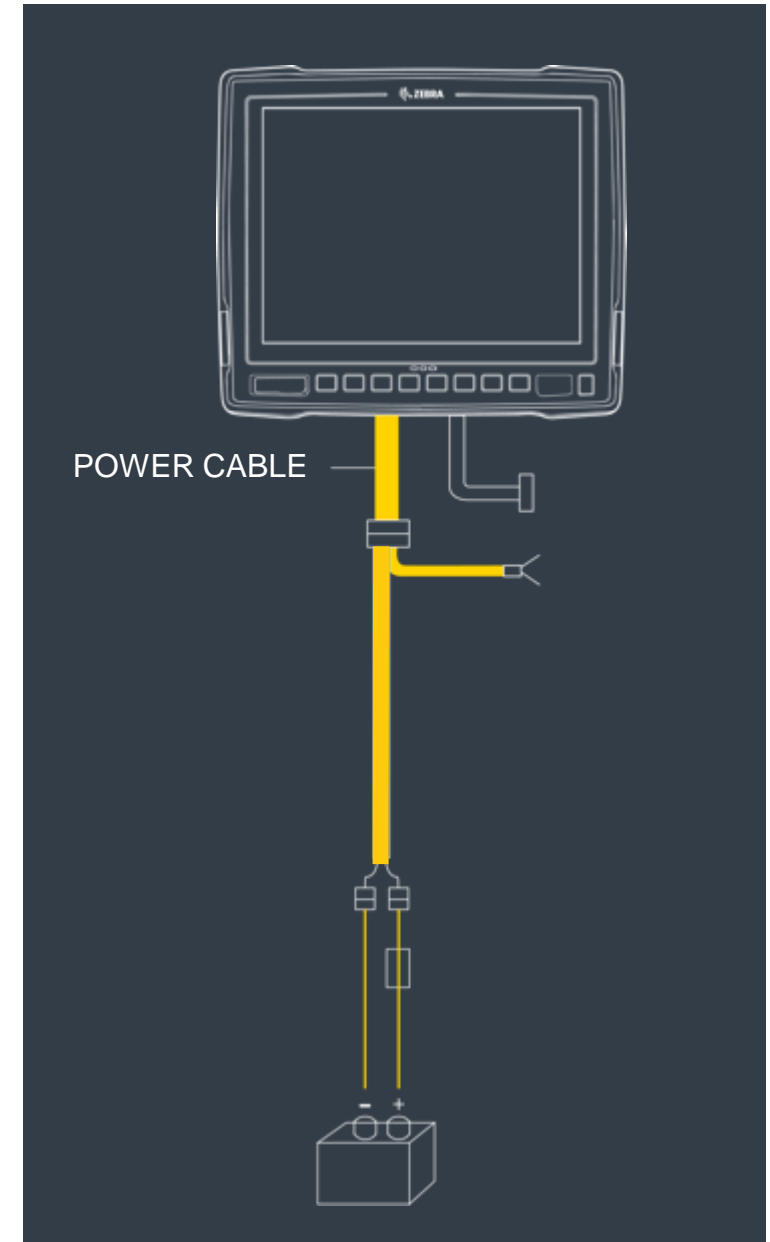

# Step 1

## Power Supplies & Cables

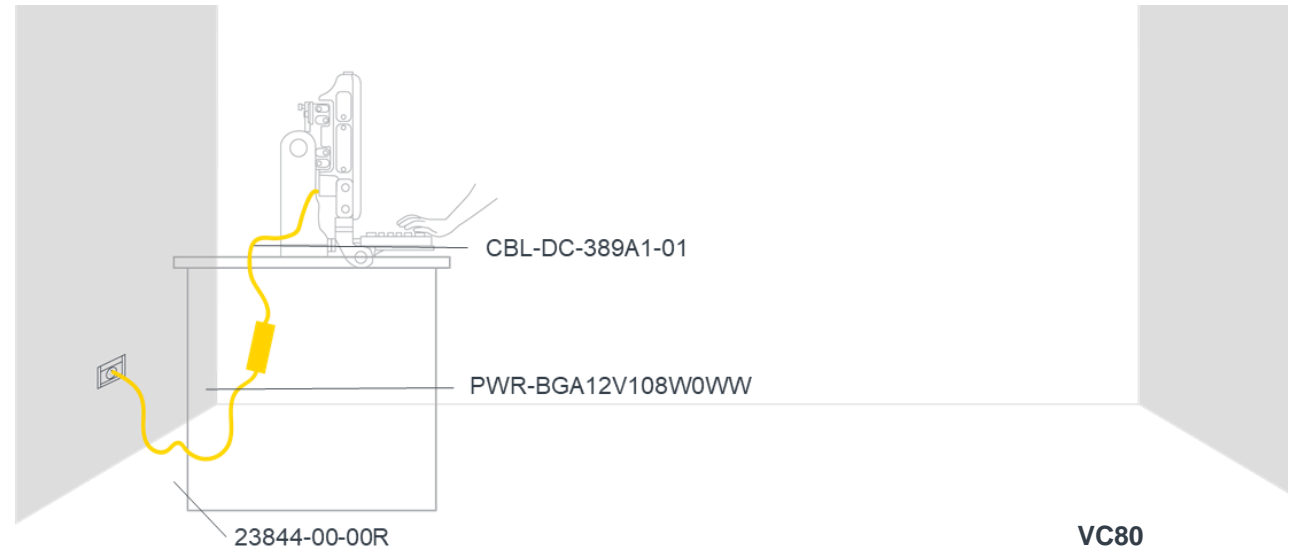

### POWERED BY PLUGGING INTO AN AC WALL OUTLET

		VH10	VC70	VC80 VC80x	VC8300
	<b>AC POWER CABLE</b>   ID: 23844-00-00R US AC line cord, 7.5 feet long, grounded, three wire for the AC power supplies PS1450 and PWR-BGA12V108W0WW. Associated Countries: United States.	•	•	•	•
	<b>AC POWER SUPPLY for VC70</b>   ID: PWR-BGA12V108W0WW Order country specific 3 wire grounded AC line cord separately.		•		
	<b>DC POWER SUPPLY ADAPTER CABLE for VC70</b>   ID: CBL-DC-389A1-01 6.5', required when the PWR-BGA12V108W0WW is used.		•		
	<b>AC POWER SUPPLY for VH10, VC80, VC80x &amp; VC8300</b>   ID: PS1450 100/240 VAC Power Supply, 12V, 6A, order AC cable separate	•			•
	<b>AC POWER SUPPLY for VC80 and VC80x</b>   ID: PWR-BGA24V150W0WW 100/240 VAC Power Supply, 24V, 6.5A, order AC cable separate				•



# Step 1:

## Power Supplies & Cables

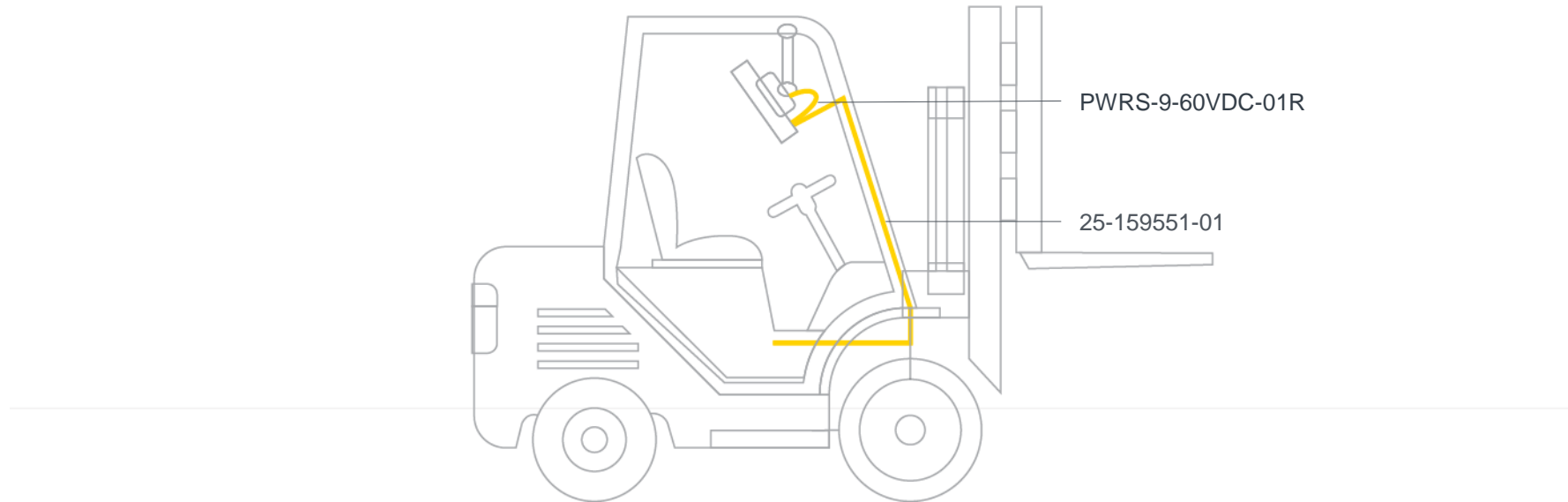

PWRS-9-60VDC-01R

25-159551-01

**VC70**

**VEHICLE MOUNT (DC POWER SUPPLY MOUNTED ON THE VC70)**

Buy both



**DC POWER SUPPLY | ID: PWRS-9-60VDC-01R**

External DC Power supply, VC70, 9-60VDC Requires 25-159551-01 fused DC power cable to vehicle battery



**DC POWER CABLE | ID: 25-159551-01**

Cable, external 9-60V DC power supply to vehicle battery, 10', includes fuse, VC70. Required for the PWRS-9-60VDC-R

# Step 1:

## Power Supplies & Cables

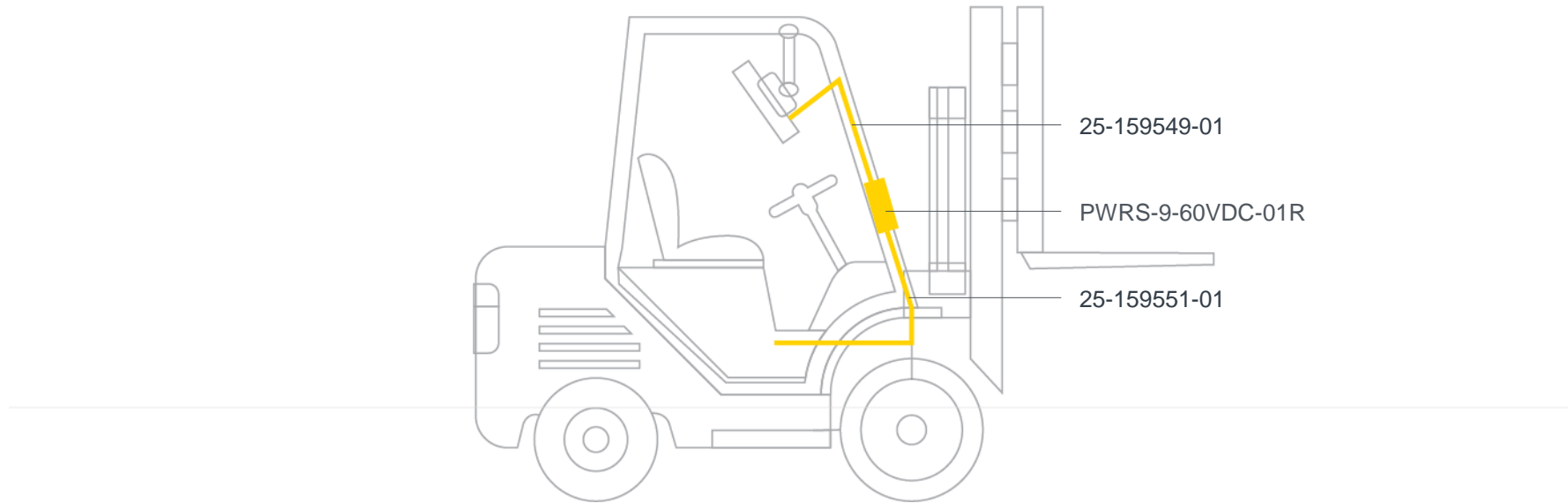

25-159549-01

PWRS-9-60VDC-01R

25-159551-01

**VC70**

**VEHICLE MOUNT (DC POWER SUPPLY NOT MOUNTED ON THE VC70)**

Buy all of these



**EXTENSION CABLE | ID: 25-159549-01**

Cable, external power supply to VC70 extender. 6.5', VC70. Required when the PWRS-9-60VDC-01R is not mounted on the back of the VC70.



**DC POWER SUPPLY | ID: PWRS-9-60VDC-01R**

External DC Power supply, VC70, 9-60VDC Requires 25-159551-01 fused DC power cable to vehicle battery



**DC POWER CABLE | ID: 25-159551-01**

Cable, external 9-60V DC power supply to vehicle battery, 10', includes fuse, VC70. Required for the PWRS-9-60VDC-R



# Step 1:

## Power Supplies & Cables

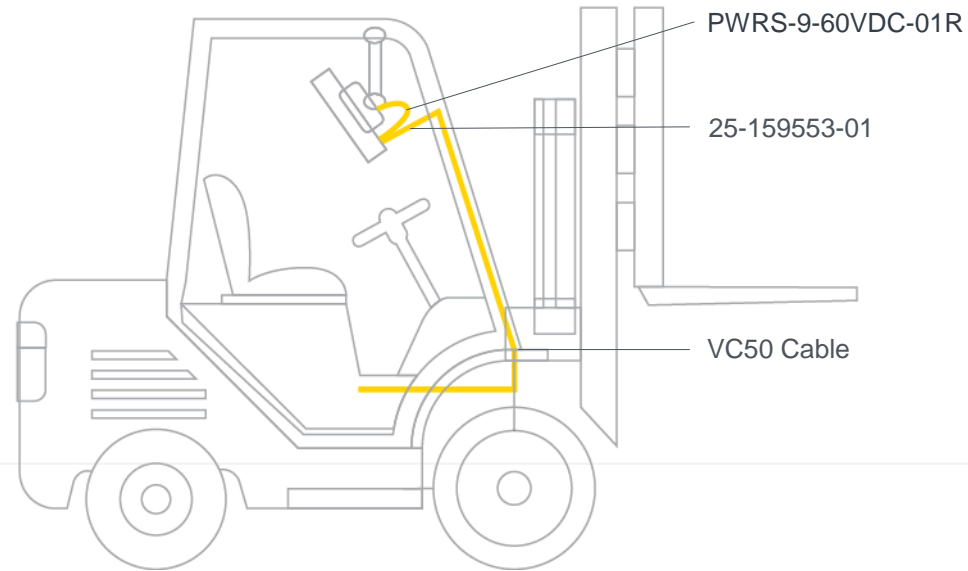

**VC70**

**VEHICLE MOUNT (WHEN REPLACING THE VC50 AND REUSING THE VC50 DC POWER CABLE)**

Buy both



**DC POWER SUPPLY | ID: PWRS-9-60VDC-01R**

External DC Power supply, VC70, 9-60VDC Requires 25-159551-01 fused DC power cable to vehicle battery



**POWER ADAPTER CABLE | ID: 25-159553-01**

Cable, external power supply to existing VC5090 power cable (25-71919-03R or 25-71919-04R), includes fuses, 2', VC70

# Step 1:

## Power Supplies & Cables

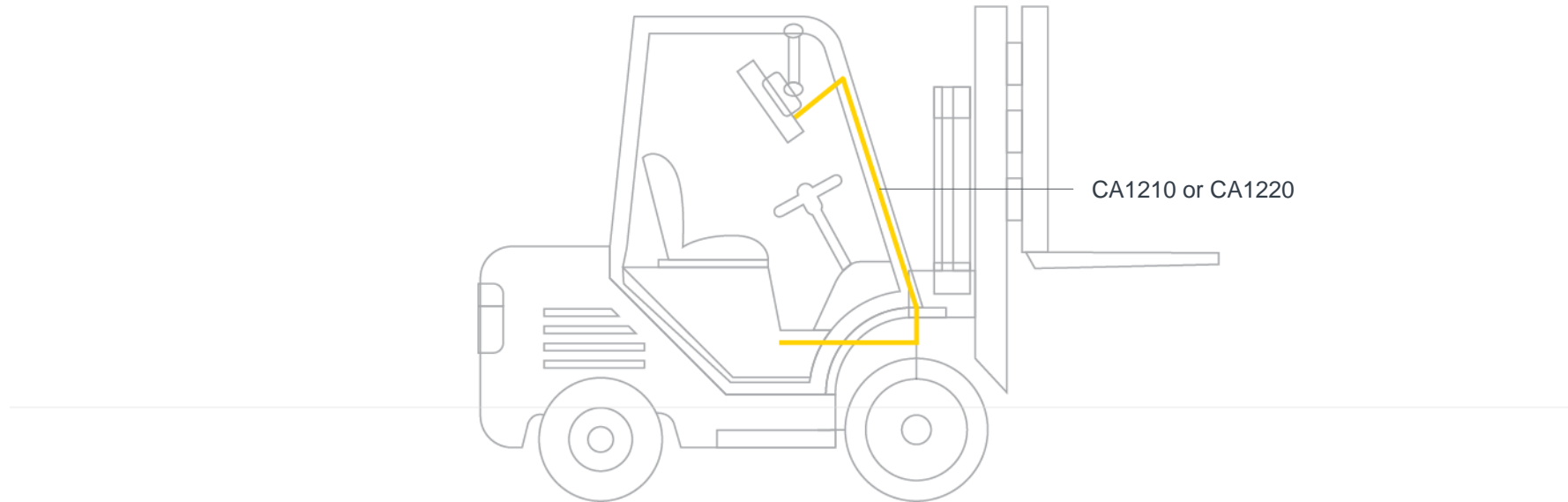

VH10, VC80, VC80x, VC8300

VEHICLE MOUNT (POWER SUPPLY IS INSIDE THE COMPUTER)

Pick one



**DC POWER CABLE | ID: CA1210**

Power Extension Cable, DC, 6', waterproof



**DC POWER CABLE | ID: CA1220**

Power Extension Cable DC, 6', waterproof - Includes Screen Blanking feature

# Step 1:

## Power Supplies & Cables

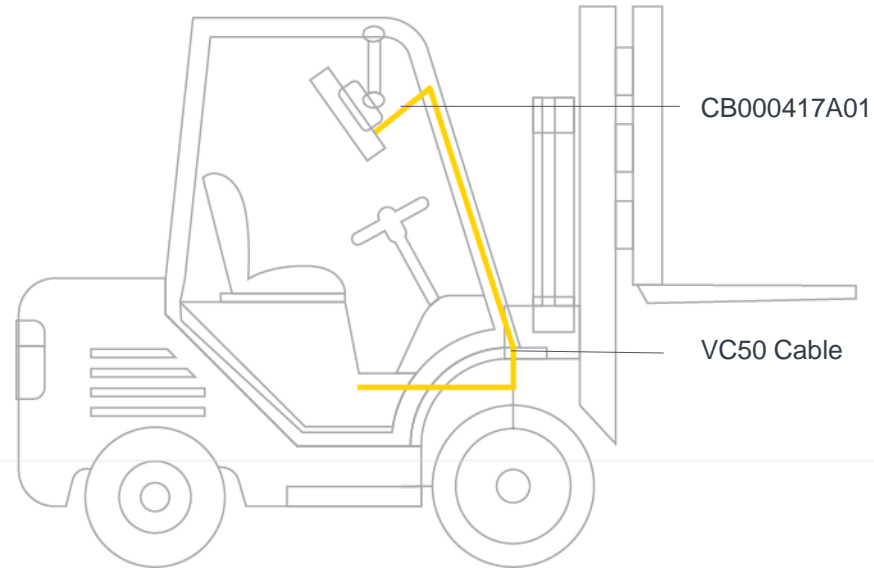

VH10, VC80, VC80x, VC8300

VEHICLE MOUNT (WHEN REPLACING VC50 AND REUSING THE VC50 DC POWER CABLE)



**POWER ADAPTER CABLE | ID: CB000417A01**  
DC Power Adapter to VC50

# Step 1:

## Power Supplies & Cables

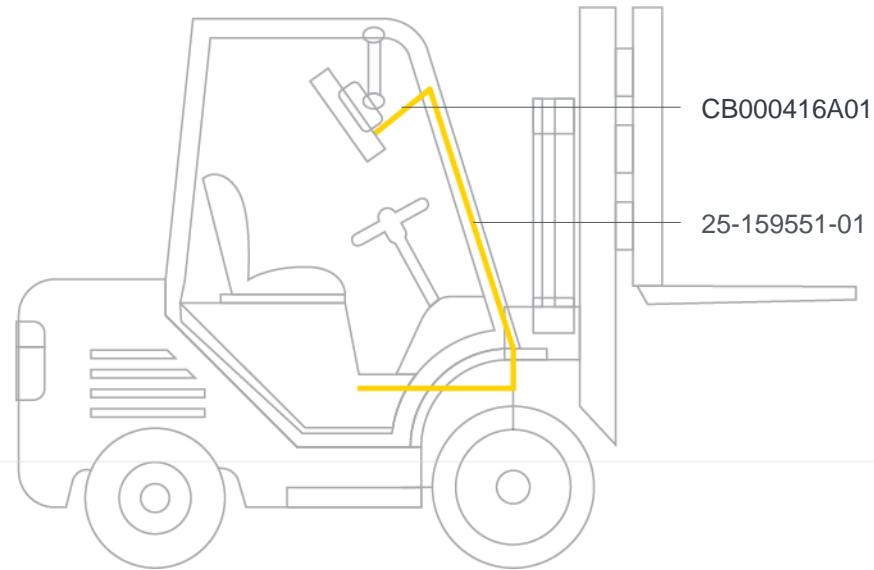

VH10, VC80, VC80x, VC8300

VEHICLE MOUNT (WHEN REPLACING VC70 AND REUSING THE VC70 DC POWER CABLE)



**POWER ADAPTER CABLE | ID: CB000416A01**

DC Power Adapter to VC70

# Step 1:

## Power Supplies & Cables

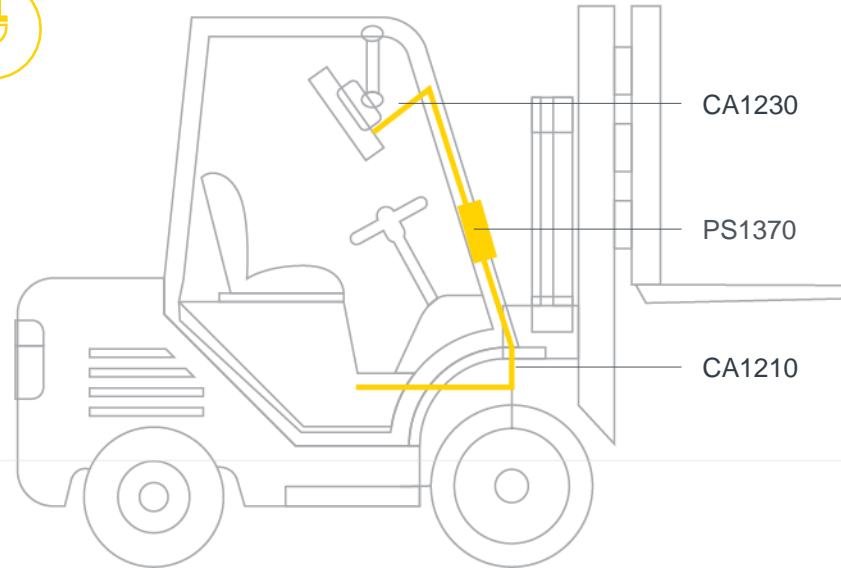

VH10, VC80, VC80x, VC8300

**VEHICLE MOUNT (WITH PRE-REGULATOR TO DECREASE VOLTAGE - FOR TRUCKS WITH BATTERIES GREATER THAN 48V)**

Buy all three



**DC POWER CABLE | ID: CA1230**  
Power extension cable for pre-regulator with ignition sense



**PRE-REGULATOR | ID: PS1370**  
Pre-Regulator, 24 - 90 VDC in, 15 VDC out, 90 W



**DC POWER CABLE | ID: CA1210**  
Power Extension Cable, DC, 6', waterproof

# Step 1:

## Power Supplies & Cables

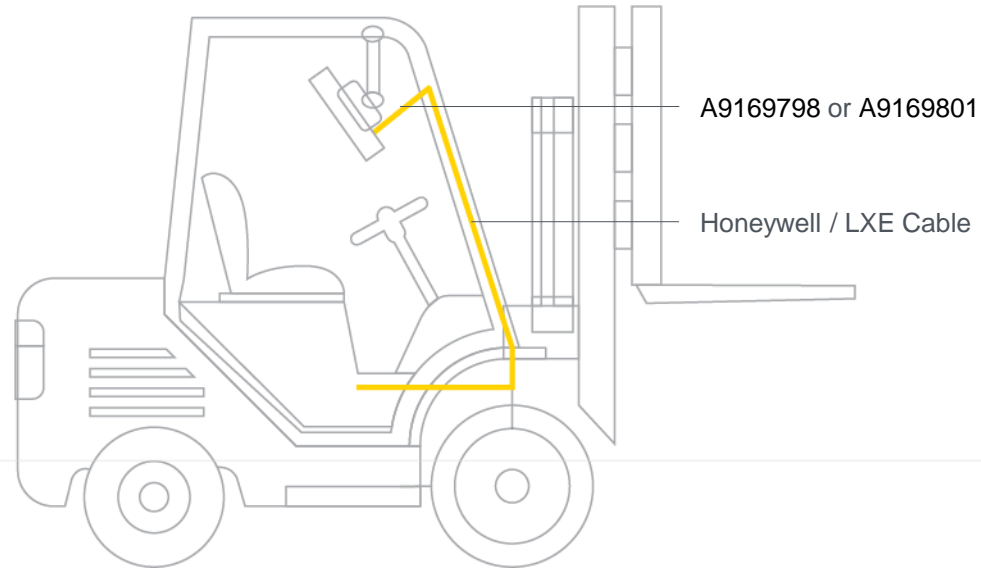

VH10, VC80, VC80x, VC8300

**VEHICLE MOUNT (WHEN REPLACING A HONEYWELL/LXE VC AND REUSING THE DC POWER CABLE)**



**POWER ADAPTER CABLE | ID: A9169798**

Adapter CPC to LXE/Honeywell VX8, VX9, VM1, VM2 AND VM3 DC Power Extension Cable



**POWER AND SCREEN BLANKING ADAPTER CABLE | ID: A9169801**

Adapter CPC and serial to LXE VX8 and VX9 DC Power Extension and Screen Blanking Cable

## Step 2:

### Mounts



- Your mounting options depend on your computer
  - For VH10, VC80, VC80x, VC8300, choose the following (slides 16/17):
    - RAM Mount
    - Quick-Release Mount
    - Adapter bracket for 82XX mounts
    - Adapter brackets for legacy VCs
  - For the VC70, choose one (slide 18):
    - RAM Mount
    - U Mount
    - Adapter bracket for VC50 mount
  - You can also select a RAM FIXED mount based on your vehicle that works with the VH10, VC70, VC80, VC80x and VC8300 (slide 19)

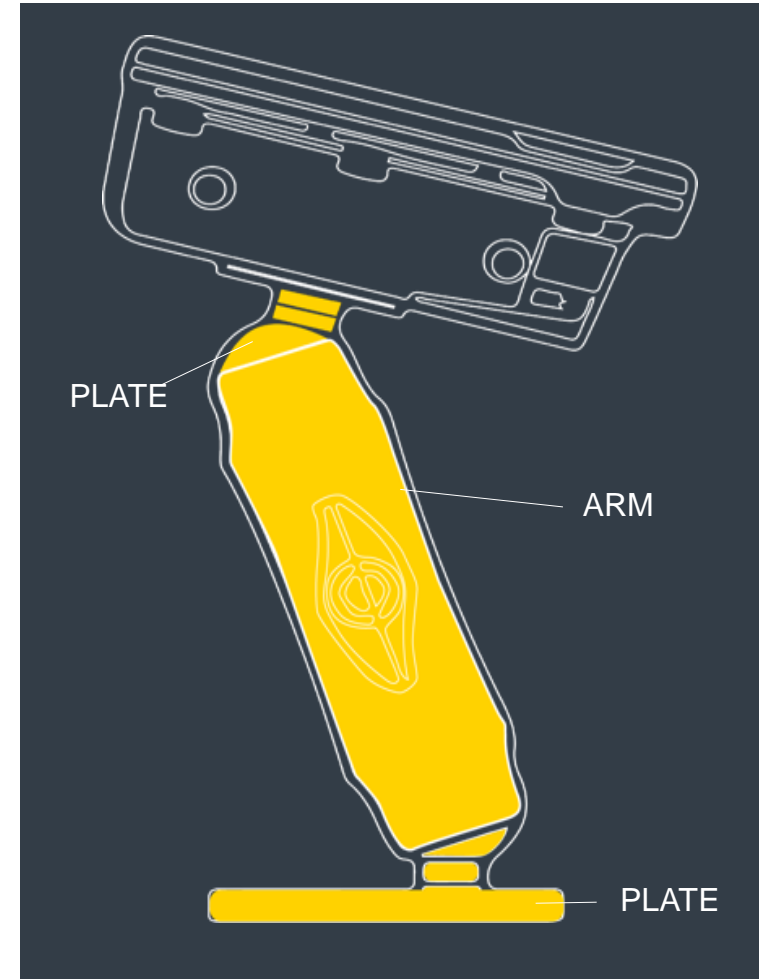

# Step 2:

## Mounts

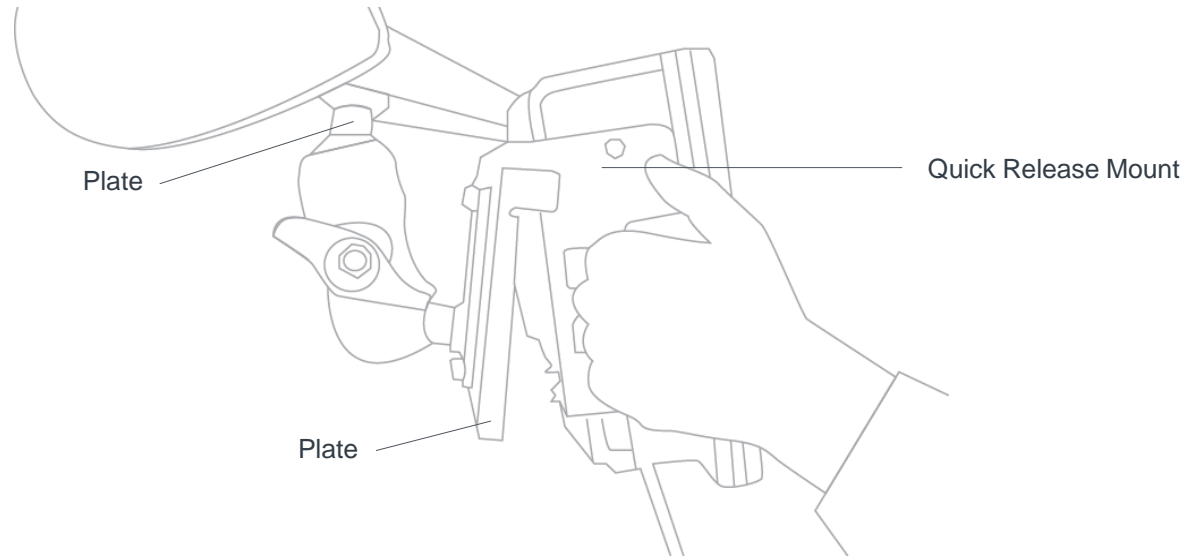

FOR VH10, VC80, VC80x, VC8300

DO YOU NEED A RAM MOUNT, A QUICK RELEASE MOUNT, OR ADAPTERS TO OLD 82XX MOUNTS?



**QUICK RELEASE MOUNT** | ID: MT4200

Quick release mount. Attaches to the side of the computer and includes Mounting Plate (MT4205) that attaches to forklift.



**PLATE** | ID: MT4205

Mounting plate for MT4200, Quick Release Mount, needed if you have one computer for multiple trucks



**ADAPTER BRACKET** | ID: MT4210

Adapter bracket kit for the older 82XX mounts



**PLATE** | ID: MT3501

VESA plate (for 4" or 12" RAM arm), Can also be attached to Quick Release Mount Plate (MT4205)



**PLATE** | ID: MT4510

RAM 2"x3" rectangular base with 2.25" rubber ball. Can be attached directly to VH10, VC80, VC80x and VC8300



# Step 2:

## Mounts



**FOR VH10, VC80, VC80x, VC8300**

**DO YOU REPLACE A LEGACY ZEBRA OR HONEYWELL/LXE VC?**



### ADAPTER FOR VC50 U-MOUNT

| ID: MNT-VC80-ADPA1-1

The adapter brackets for the VC50 U-Mount can be used to replace a VC50 by a VH10, VC80, VC80x or a VC8300 and reuse the existing U-Mount.



### U-MOUNT, WITH VC70 U-MOUNT HOLE PATTERN

| ID: KT-U-MOUNT-VC80-R

The VC80 Series U-Mount is smaller than the one for the VC50 and has several mounting holes which allow drop-in replacements of VC70, and DLoG U-Mounts. It provides step less tilting of the VC and comes with the VC50 adapters.



### ADAPTER FOR HONEYWELL U-MOUNT

| ID: MNT-VC80-ADPB1-1

The adapter brackets for the Honeywell U-Mount can be used to replace a Honeywell/LXE VC by a VH10, VC80, VC80x or a VC8300 and reuse the existing U-Mount (Honeywell part number VM1010BRKTKIT).

# Step 2: Mounts

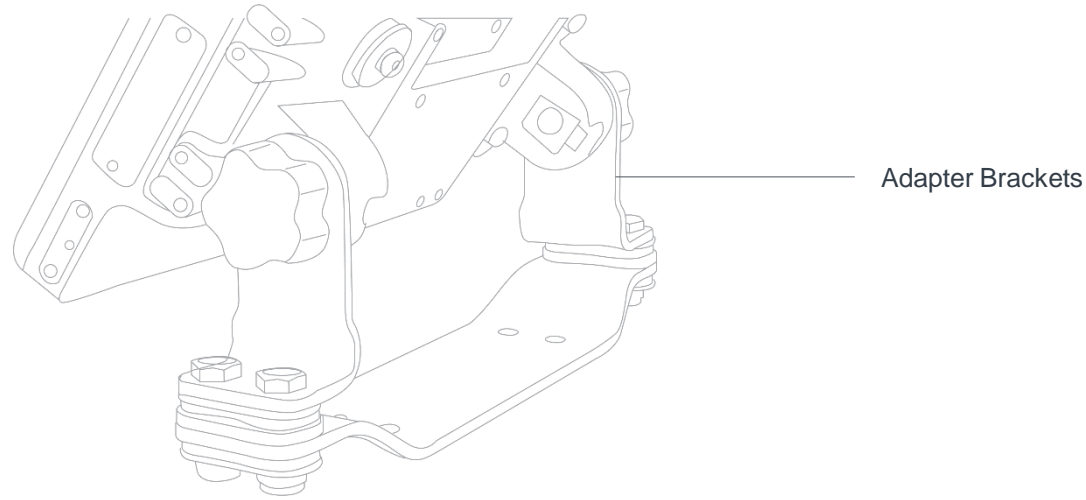

Adapter Brackets

## FOR THE VC70

## DO YOU NEED A RAM MOUNT, AN U MOUNT, OR ADAPTER BRACKETS TO THE VC50 U MOUNT?



### RAM MOUNT | ID: RAM-D-2461U-MOTO7

RAM bridge with RAM-D-2461U RAM MOUNT, D (2.25") size ball with screws. Including screws to mount the PWRS-9-60VDC-01R External DC Power Supply. Used when replacing equipment already mounted with RAM mounts



### RAM MOUNT | ID: RAM-D-2461U-MOTO7B

RAM-D-2461U RAM MOUNT, D (2.25") size ball with screws. Used when the PWRS-9-60VDC-01R External DC Power Supply has to be mounted away or when AC power supply is used. Used when replacing equipment already mounted with RAM mounts



### U MOUNT | ID: KT-U-MOUNT-VC70-R

U mount, VC70, with mounting hardware



### ADAPTER BRACKET | ID: KT-VC50ARM3-VC70-R

2 mount adapter arms for VC50 bracket, 3.5", with bolts



### ADAPTER BRACKET | ID: KT-VC50ARM7-VC70-R

2 mount adapter arms for VC50 bracket, 7", with bolts









# Step 2:

## Mounts



VH10, VC70, VC80, VC80x, VC8300

DEPENDING ON THE VEHICLE, BELOW ARE THE RAM FIXED MOUNTING OPTIONS TO THE COMPUTER AND/OR THE VEHICLE.

	<b>ARM   ID: MT4301</b> RAM mount, 4" arm
	<b>ARM   ID: MT4302</b> RAM mount, 12" arm
	<b>PLATE   ID: MT3501</b> VESA plate (for 4" or 12" RAM arm), Can also be attached to Quick Release Mount Plate (MT4205)
	<b>PLATE   ID: MT3502</b> Round plate (for 4" or 12" RAM arm), Uses smaller footprint than MT3501 VESA Plate
	<b>BASE   ID: MT3505</b> Clamp base (for 4" or 12" RAM arm), 2" max. width
	<b>BASE   ID: MT3507</b> Clamp base (for 4" or 12" RAM arm), 3" max. width
	<b>BASE   ID: MT3509</b> Rail base (for 4" or 12" RAM arm), 1-1/4" to 1-7/8"
	<b>BASE   ID: MT3510</b> Rail base (for 4" or 12" RAM arm), 2" to 2 1/2"
	<b>BASE   ID: MT4510</b> RAM 2"x3" rectangular base with 2.25" rubber ball

## Step 3:

### Scanners



- When shopping for scanner cables, choose between coiled or straight for your scanner and between an RS232 or USB plug.
- Scanner Cables for LI/DS36XX (slide 21)
- Scanner cables for LS/DS 34XX/35XX (slide 21)
- Scanner holders (slide 22)

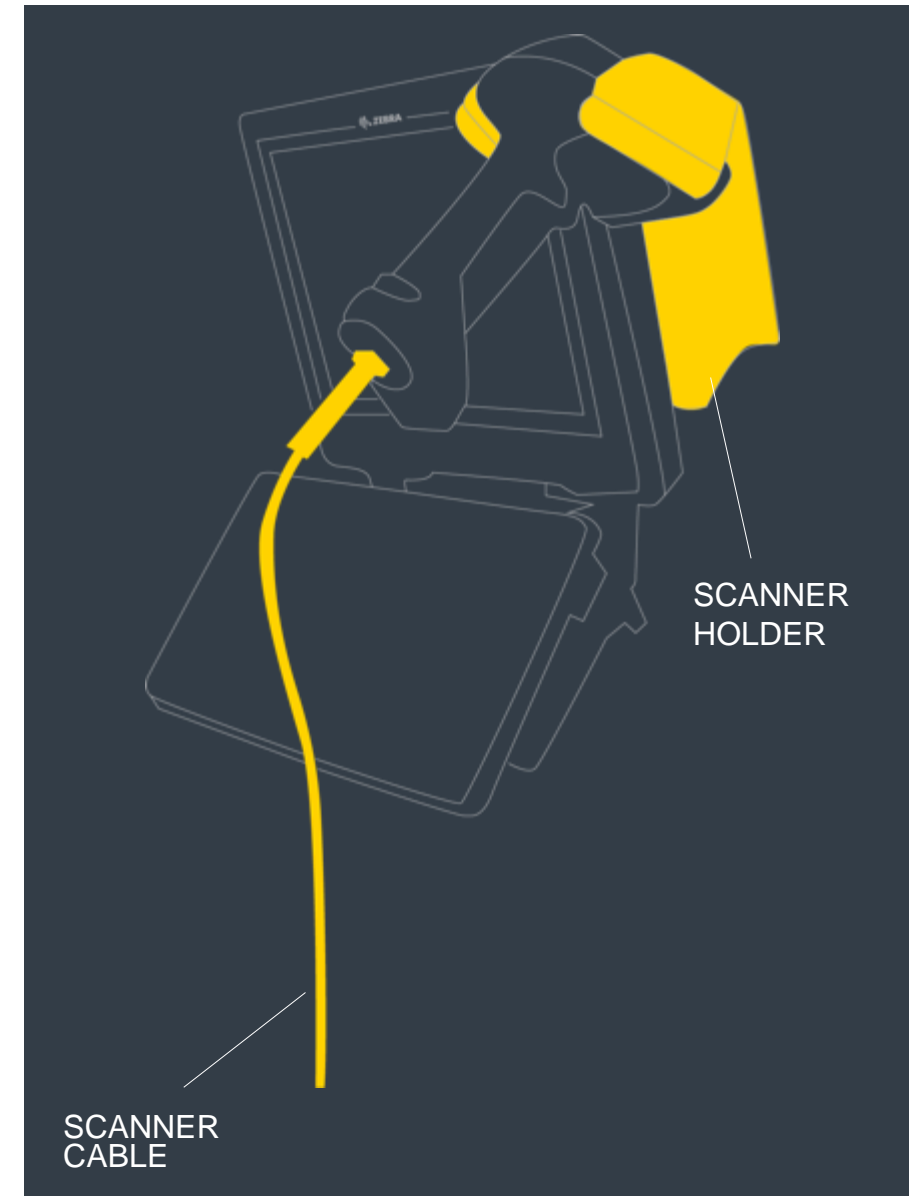

# Step 3:

## Scanners







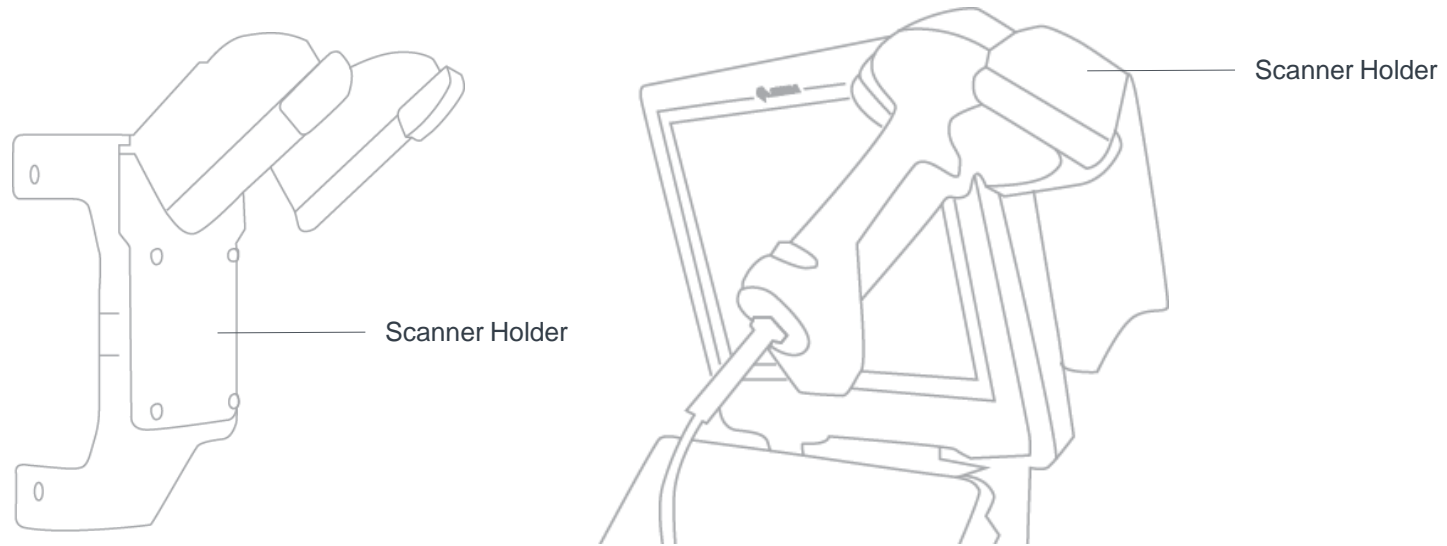

LI/DS36XXXX		SCANNER CABLES			
Photo Not Available	<b>RS232</b>   ID: CBA-RF3-C09ZAR Cable - RS232: DB9 Female Connector, 9ft. (2.8m) Coiled, Power Pin 9, TxD on 2, True Converter, -30C			•	
	<b>SHIELDED USB</b>   ID: CBA-UF2-C12ZAR Cable - Shielded USB: Series A Locking Connector for VC70, 12', Coiled, -30C			•	
	<b>RS232</b>   ID: CBA-R71-C09ZAR Cable - RS232: DB9 Female Connector, 9ft (2.8m) Coiled, Power Pin 9	•			•
Photo Not Available	<b>RS232</b>   ID: CBA-RF2-C09ZAR Cable - RS232: DB9 Female Connector, 9ft (2.8m) Coiled, Power Pin 9, -30C	•			•
	<b>SHIELDED USB</b>   ID: CBA-U46-S07ZAR Cable - Shielded USB: Series A Connector, 7ft. (2m), Straight, BC 1.2	•			•
Photo Not Available	<b>SHIELDED USB</b>   ID: CBA-U47-S15ZAR Cable - Shielded USB: Series A Connector, 15ft. (4.6m), Straight, BC 1.2	•			•
Photo Not Available	<b>SHIELDED USB</b>   ID: CBA-UF1-S07ZAR Cable - Shielded USB: Series A Connector, 7ft. (2m), Straight, BC 1.2, -30C	•			•
LS/DS 34XX/35XX		SCANNER CABLES			
	<b>SHIELDED USB</b>   ID: 25-159548-01 Cable - Shielded USB: Series A Locking Connector for VC70, 12', Coiled, -30C			•	
Photo Not Available	<b>RS232</b>   ID: CBA-R46-C09ZBR Cable - RS232: DB9 Female Connector, 9ft. (2.8m) Coiled, Power Pin 9, TxD on 2, True Converter			•	
Photo Not Available	<b>RS232</b>   ID: CBA-R49-C09ZAR Cable - RS232: DB9 Female Connector, 9ft. (2.8m) Coiled, Power Pin 9, TxD on 2, True Converter, Low Temp -30C			•	
	<b>RS232</b>   ID: CBA-R37-C09ZAR Cable - RS232: DB9 Female Connector, 9ft (2.8m) Coiled, Power Pin 9	•			•
Photo Not Available	<b>USB</b>   ID: CBA-U09-C15ZAR Cable - USB: Series A Connector, 15ft. (4.6m) Coiled	•			•
Photo Not Available	<b>SHIELDED USB</b>   ID: CBA-U01-S07ZAR Cable - Shielded USB: Series A Connector, 7ft. (2m), Straight, BC 1.2	•			•
Photo Not Available	<b>SHIELDED USB</b>   ID: CBA-U10-S15ZAR Cable - Shielded USB: Series A Connector, 15ft. (4.6m), Straight, BC 1.2	•			•

# Step 3:

## Scanner Holders



		VH10	VC8300	VC70	VC80 VC80x
	<b>SCANNER HOLDER   ID: KT-SCANMNT-VC70-R</b> Mounting holder for the scanner. For LS34x8ER, LS35x8ER. Requires KT-ACCMNT-VC70-R Accessory side mount bracket				
	<b>ACCESSORY MOUNT   ID: KT-ACCMNT-VC70-R</b> Accessory side mount bracket			•	
	<b>SCANNER HOLDER   ID: KT-SCANMNT-VC80-R</b> Side mounted holder for scanner		•		•

# Step 4:

## Keyboards

- While the VH10 and the VC8300 have built-in keyboards, the VC70, VC80 and VC80x give you multiple options
  - VC80 and VC80x Keyboards (slide 24)
  - VC70 Keyboards (slide 25)

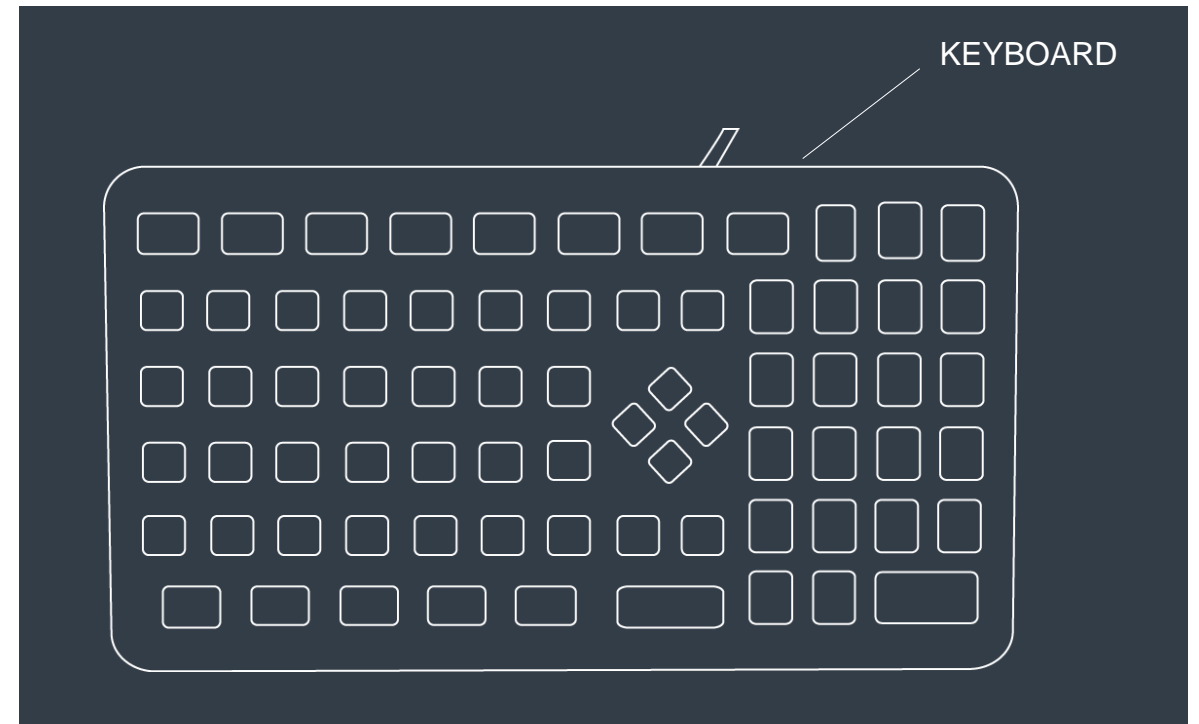

# Step 4:

## VC80 & VC80x Keyboards, Cables and Mounting Options



**KEYBOARD | ID: KYBD-AZ-VC-01**  
VC USB Keyboard AZERTY



**KEYBOARD | ID: KYBD-QW-VC80-S-1**  
USB Keyboard QWERTY with 22 cm cable for VC80/VC80x



**KEYBOARD | ID: KYBD-QW-VC80-L-1**  
USB Keyboard QWERTY with 300 cm cable for VC80/VC80x



**KEYBOARD CABLE | ID: CBL-VC80-KBUS1-01**  
22 cm VC80 Series USB cable for heated Keyboard



**KEYBOARD CABLE | ID: CBL-VC80-KBUS2-01**  
300 cm VC80 Series USB cable for heated Keyboard



**KEYBOARD | ID: KYBD-NU-VC70-03R**  
USB Keyboard QWERTY with 300 cm y-cable for VC70 Freezer



**KEYBOARD TRAY | ID: KT-KYBDTRAY-VC80-R**  
QWERTY/AZERTY Keyboard mounting tray. Includes tilting arms, knobs and screws.



**KEYBOARD SIDE MOUNT BRACKET | ID: KYBD-NU-VC80-03R**  
Function/Numeric keypad side mount bracket



# Step 4:

## VC70 Keyboards, Cables and Mounting Options



**KEYBOARD | ID: KYBD-AZ-VC-01**  
VC USB Keyboard AZERTY



**KEYBOARD | ID: KYBD-QW-VC70-S-1**  
USB Keyboard QWERTY with 18 cm cable for VC70



**KEYBOARD | ID: KYBD-QW-VC70-L-1**  
USB Keyboard QWERTY with 300 cm cable for VC70



**KEYBOARD | ID: KYBD-QW-VC70F-S-1**  
USB Keyboard QWERTY with 37 cm y-cable for VC70 Freezer



**KEYBOARD | ID: KYBD-QW-VC70F-L-1**  
USB Keyboard QWERTY with 300 cm y-cable for VC70 Freezer



**KEYBOARD CABLE | ID: CBL-VC70-KBUS1-01**  
18 cm VC70 USB cable for heated Keyboard



**KEYBOARD CABLE | ID: CBL-VC70-KBUS2-01**  
300 cm VC70 USB cable for heated Keyboard



**KEYBOARD CABLE | ID: CBL-VC70-KBUS4-01**  
37 cm VC70 USB & RS232 Y-cable for heated Keyboard



**KEYBOARD CABLE | ID: CBL-VC70-KBUS4-01**  
300 cm VC70 USB & RS232 Y-cable for heated Keyboard



**KEYBOARD | ID: KYBD-NU-VC70-03R**  
USB Keyboard QWERTY with 300 cm y-cable for VC70 Freezer



**KEYBOARD TRAY | ID: KT-KYBDTRAY-VC70-3**  
QWERTY/AZERTY Keyboard mounting tray. Includes tilting arms, knobs and screws.



**KEYBOARD SIDE MOUNT BRACKET | ID: KT-KYBDMNT-VC70-R**  
Function/Numeric keypad side mount bracket

# Step 5:

## Antennas



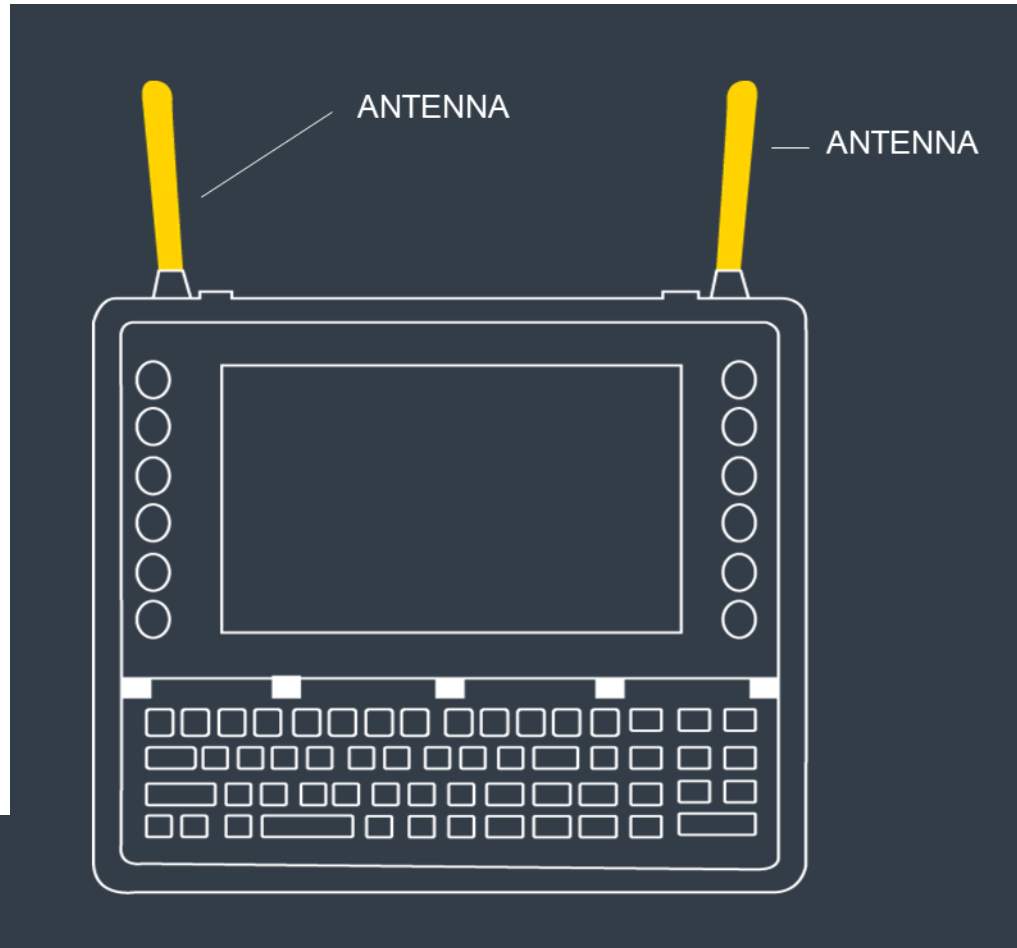



- Your options of antennas are wide (slides 27/28):
  - Wi-Fi: VH10, VC70, VC80, VC80x, VC8300
  - Narrowband: VH10 Only
  - GPS: VC80 Only
  - Right-angle adapter for installations with little overhead space
    - VH10, VC70, VC80, VC80x, VC8300



# Step 5:

## Antennas & Connectivity to choose from





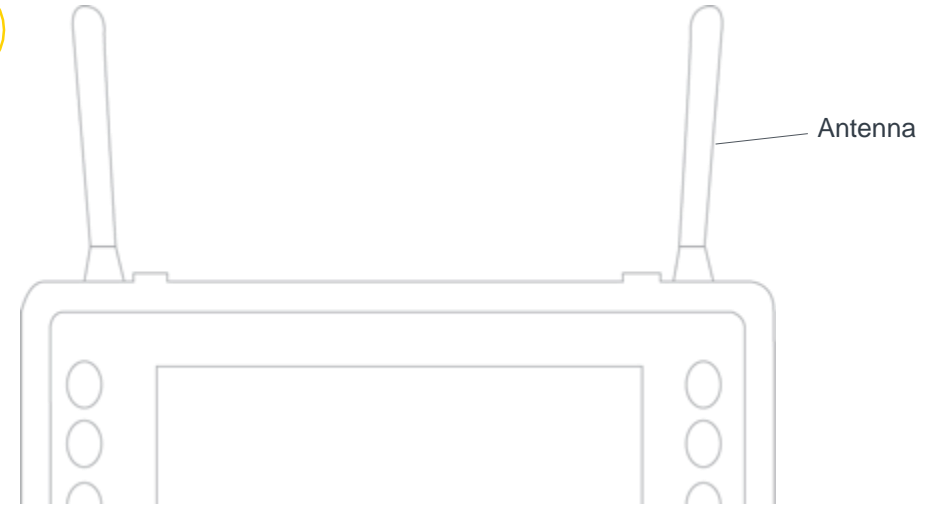

ALL VCS	ANTENNAS & CONNECTIVITY FOR WIFI
	<b>ANTENNA   ID: 20667-002</b> Whip antenna (stubby), 802.11 b/g - dipole 2 dBi reverse polarity SMA connector
	<b>ANTENNA   ID: AN2010</b> Antenna, dual band, 802.11 a/b/g/n, 2 dBi, RPSMA connector, magnetic mount, 2.9m
	<b>ANTENNA   ID: AN2020</b> Antenna, 2.4 GHz, 802.11 b/g, 5 dBi, RPSMA connector, magnetic mount, 2.9m
	<b>ANTENNA   ID: AN2030</b> Whip antenna (stubby), dual band, 802.11 a/b/g/n, 2.4GHz 2dBi, 5GHz 3.7 dBi, RPSMA connector, WiFi
VC70	ADAPTERS FOR VC70 TO ATTACH EXTERNAL WIFI ANTENNAS WITH RPSMA CONNECTOR
	<b>ADAPTER   ID: RPSMA-RTRPSMA-05R</b> ANTENNA ADAPTER RPSMA - RTRPSMA, 5-PACK, Required for the VC70 WiFi Antennas
	<b>ADAPTER   ID: RPSMA-RTRPSMA-10R</b> ANTENNA ADAPTER RPSMA - RTRPSMA, 10-PACK, Required for the VC70 WiFi Antennas

# Step 5:

## Antennas & Connectivity to choose from



<b>VH10</b>	<b>ANTENNAS &amp; CONNECTIVITY FOR NARROWBAND</b>
	<b>ANTENNA   ID: 9009801</b> Antenna, Narrow Band 1/4 wave, 406-512 MHz 6" NB
	<b>MOUNT   ID: 9009792</b> Mount, Magnetic, for Narrowband, antenna, SMA, 12' cable
<b>VC80</b>	<b>ANTENNA FOR GPS</b>
	<b>ANTENNA   ID: AN000090A01</b> GNSS antenna, magnetic mount, 2.9 m cable
<b>ALL VCS</b>	<b>RIGHT ANGLE ADAPTER FOR INSTALLATIONS WITH LITTLE SPACE OVERHEAD, ALL VCS</b>
	<b>RIGHT ANGLE ADAPTER   ID: AR1000</b> Right Angle SMA reverse polarity plug-jack Adapter

# Step 6:

## Voice

- Select from turnkey kits or voice accessories A LA Carte.
- Your Voice options (slide 30)
  - Voice

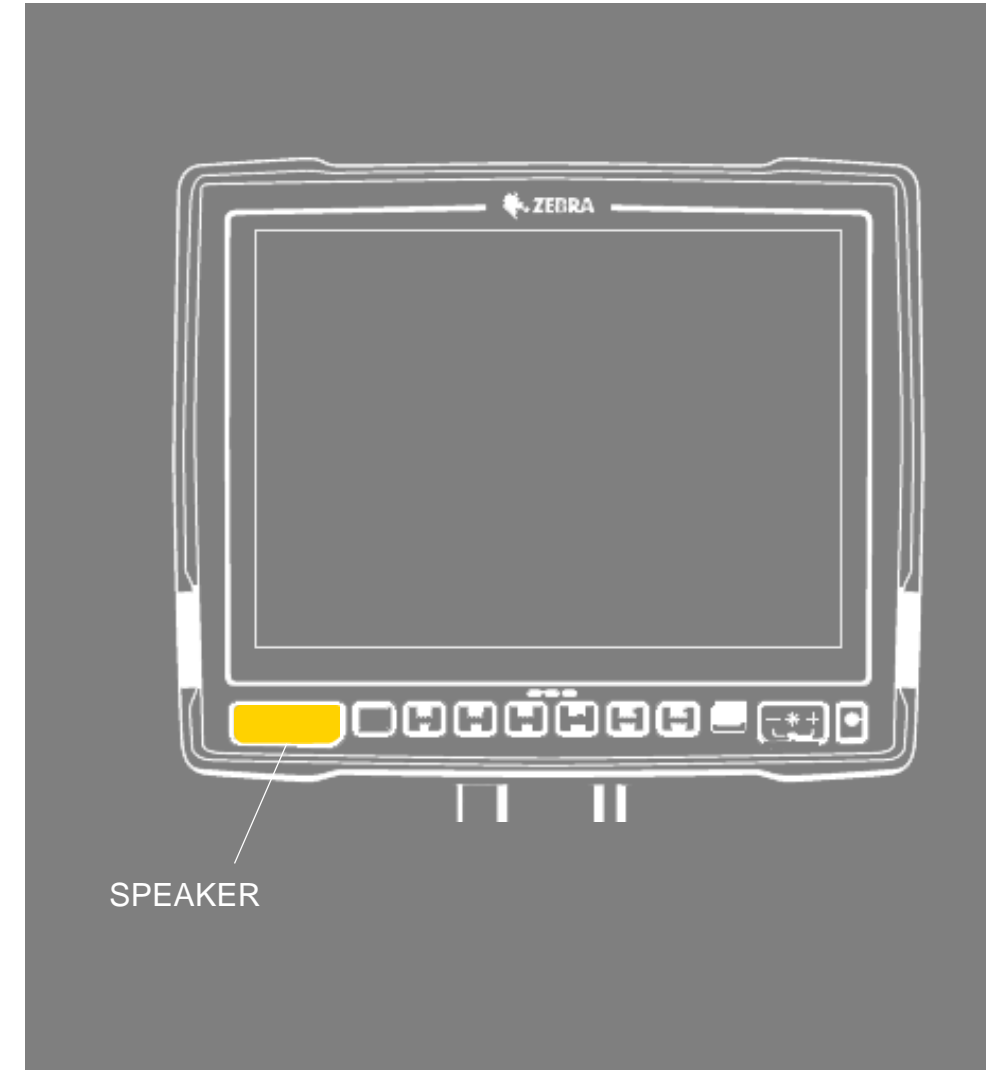
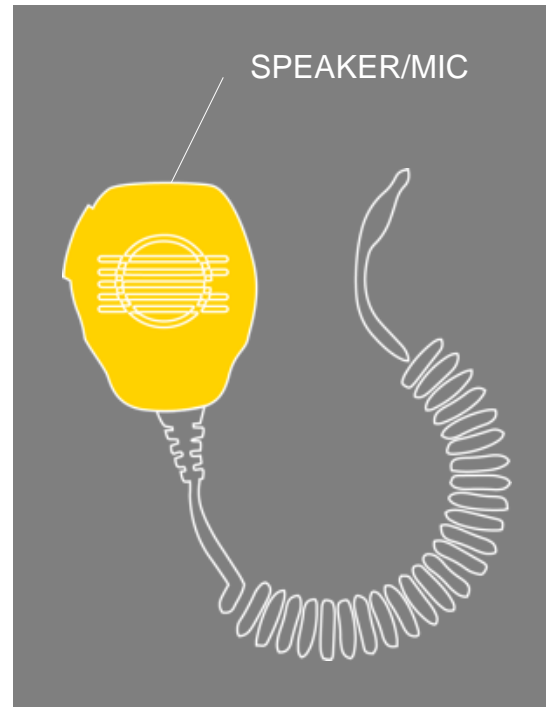

# Step 6:

Voice



		VH10	VC8300	VC70	VC80 VC80x
Photo Not Available	<b>MICROPHONE KIT   ID: KT-MIC-01R</b> This bundle includes the VC70 External PTT mic, the Motorola HMN1089B Water-resistant Palm Microphone or equivalent and the KT-ACCMNT-VC70-R Accessory Side mount bracket.			•	
	<b>MICROPHONE   ID: HMN1089B</b> Push-To-Talk Hand Microphone, GCAI connector, Water Resistant			•	
	<b>SIDE MOUNT   ID: KT-ACCMNT-VC70-R</b> Accessory Side mount bracket			•	
Photo Not Available	<b>SPEAKER KIT   ID: KT-SPKR-01R</b> This bundle includes the External speaker, the Motorola HSN4039A 13 Watt water-resistant loudspeaker and the 25-159552-01 VC70 external speaker adapter cable.			•	
	<b>SPEAKER   ID: HSN4040A</b> External speaker, Motorola HSN4040A 13 Watt water-resistant loudspeaker. Requires 25-159552-01			•	
	<b>INTERFACE CABLE   ID: 25-159552-01</b> Speaker cable adapter, for HSN4040A, VC70. Required to connect the HSN4040A external speaker.			•	
	<b>SPEAKER/MIC   ID: M1000</b> Speaker/Mic with push-to-talk function	•			•

# Step 7:

## Miscellaneous



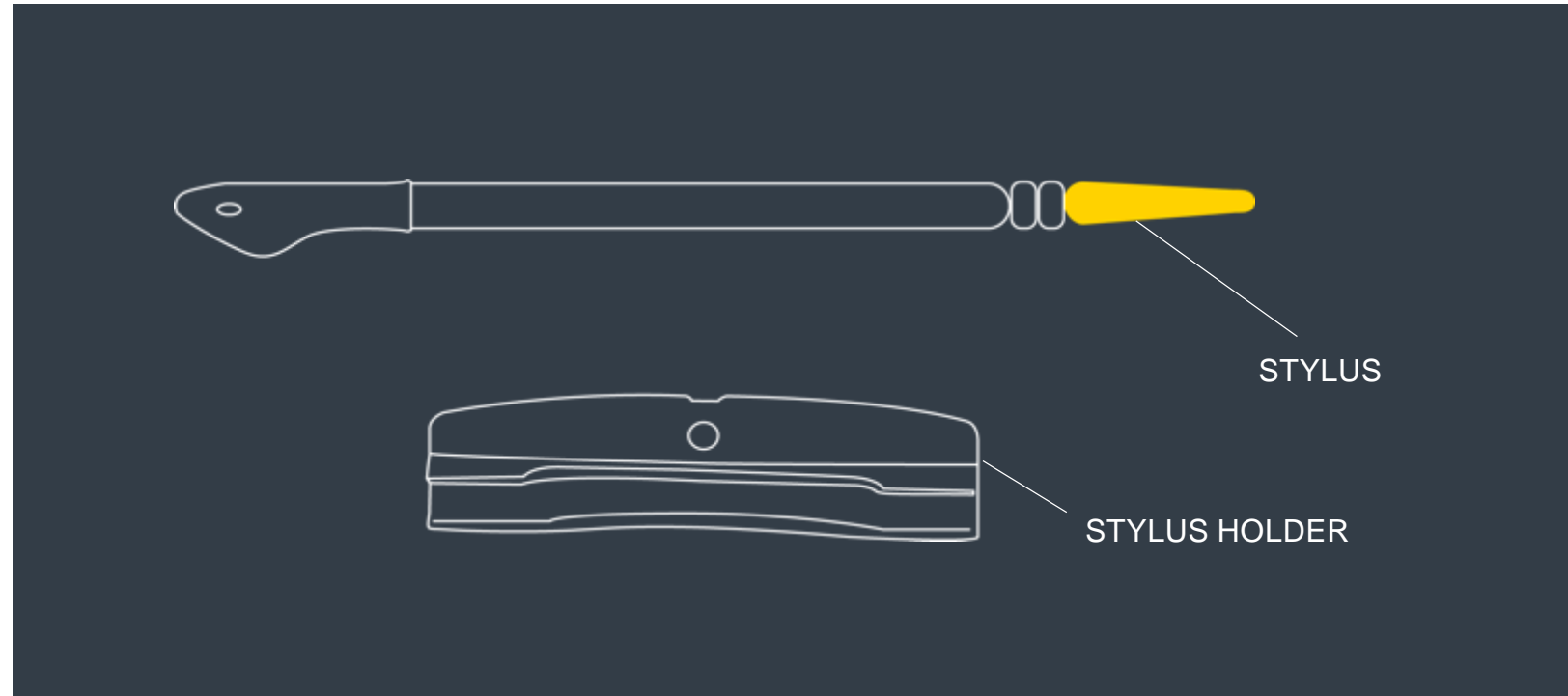





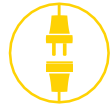



- Don't forget to consider the following accessories (slide 32)
  - Stylus
  - Screen protector
  - CAN BUS cable
  - USB to Ethernet adapter



# Step 7:

## Miscellaneous



		VH10	VC8300	VC70	VC80	VC80x
	<b>ID: SL0001</b> Stylus and Stylus Holder	 •	 •	 •	 •	 •
	<b>ID: VA6200</b> Screen Protector Pack of 3	•				
	<b>ID: KT-SPRTCT-VC70-05R</b> Screen Protector Pack of 5			•	•	•
	<b>ID: CA1300</b> Screen blanking cable (DB9 to open wires)	•	•		•	•
	<b>ID: CB-000433-01</b> CAN Bus Cable (RJ45 to Deutsch)				•	
	<b>ID: WA4070</b> USB to Ethernet Adapter	•	•		•	•
	<b>ID: 25-159547-01</b> Cable DB15M to DB9M, for COM2			•		
	<b>ID: SG-VC70-VISR1-01</b> VC70 Sun Visor mountable with cut out wing.			•		
Photo Not Available	<b>ID: KT-AREFL-VC83-8-1</b> Anti Reflection Foil		•			



# Step 8:





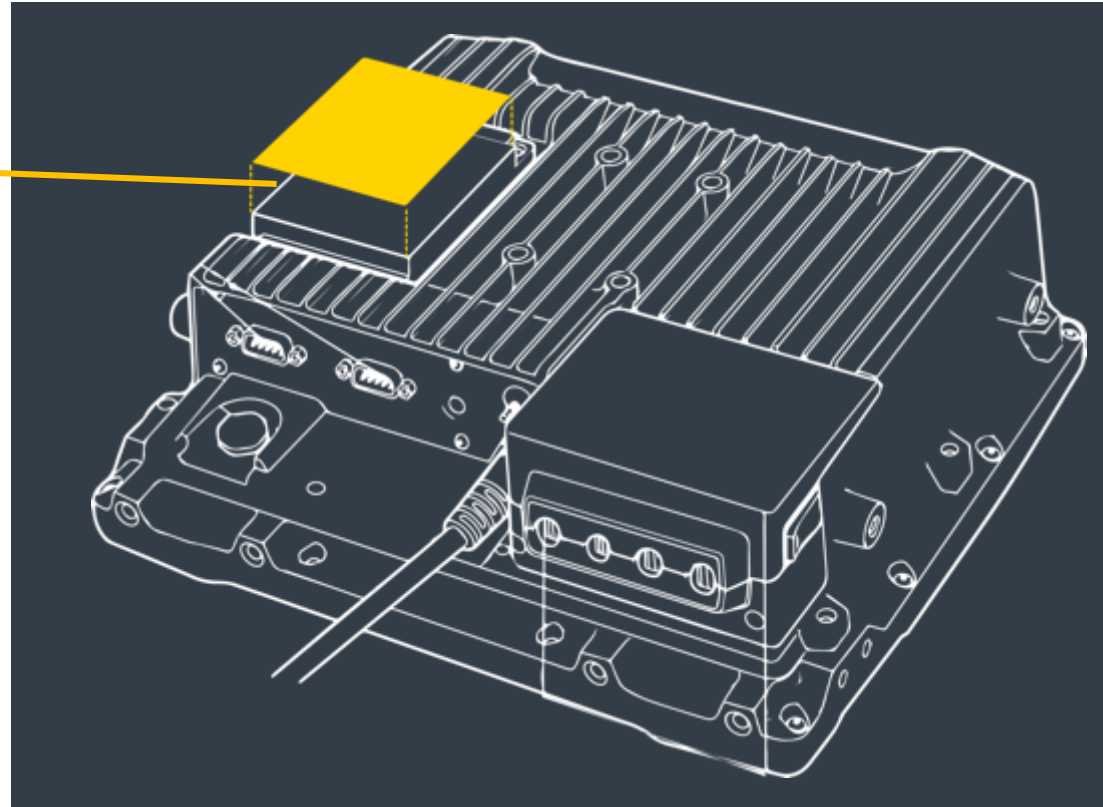

## Service Parts

- Stock up on these essential spare parts (slides 34/35)
  - Tool kit
  - Keypads
  - Touch screens
  - Spare battery







# Step 8:

## Service Parts

SERVICE PARTS		VH10	VC8300	VC70	VC80 VC80x
Photo Not Available	<b>ID: AL1001</b> QWERTY Keypad	 •			
Photo Not Available	<b>ID: AL1002</b> AZERTY Keypad	•			
Photo Not Available	<b>ID: AL2002</b> Front with standard touch screen and function keys	•			
Photo Not Available	<b>ID: AL2002</b> Front with heated touch screen and function keys	•			
	<b>ID: ST2000</b> Modular Services Kit	•	•		•
Photo Not Available	<b>ID: KT-VC80-BTRY1-01</b> Spare Battery		•		•
Photo Not Available	<b>ID: KT-VC80-SCRH1-01</b> Front with Touch Screen (heated)				•
	<b>ID: KT-VC80-SCRN1-01</b> Front with Touch Screen (non-heated)				•
Photo Not Available	<b>ID: BTRY-VC70IAB00</b> Spare Battery			•	
Photo Not Available	<b>ID: KYBD-QW-VC-01</b> QWERTY Spare Elastomer for VC USB Keyboard			•	•
Photo Not Available	<b>ID: KYBD-AZ-VC-01</b> AZERTY Spare Elastomer for VC USB Keyboard			•	•

# Step 8:

## Service Parts

SERVICE PARTS		VH10	VC8300	VC70	VC80 VC80x
	<b>ID: SPR-SMA-DC-10</b> SMA antenna connector dust caps, pack of 10	 •	 •	 •	 •
	<b>ID: TBD</b> QWERTY Keypad		•		
	<b>ID: TBD</b> AZERTY Keypad		•		
	<b>ID: TBD</b> Front with standard touch screen and function keys		•		
	<b>ID: TBD</b> Front with heated touch screen and function keys		•		