

# Honeywell

## ScanPal EDA51

Enterprise Hybrid Device  
with Android™ 8.1 Operating System

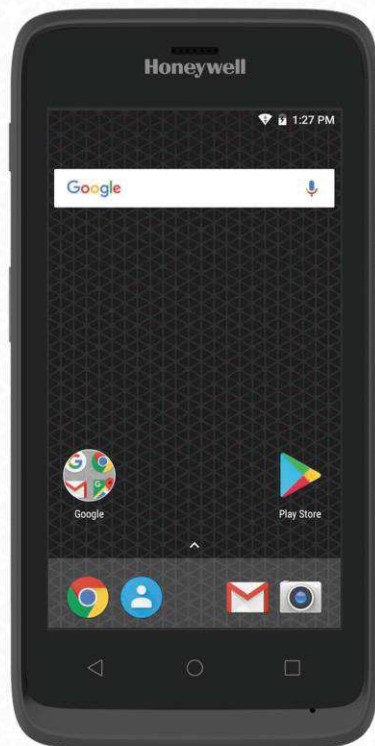

### User Guide



**BSR idware GmbH**  
Jakob-Haringer-Str.3  
A-5020 Salzburg  
<https://www.bsr.at>  
[sales@bsr.at](mailto:sales@bsr.at)

**Disclaimer**

Honeywell International Inc. (abbr. HII) reserves the rights to modify the specifications and other information mentioned in this User Guide without prior notification. In any case, users should confirm with HII whether any changes were made. This publication does not represent any commitments of HII.

HII is not responsible for any technical or editing errors or omissions contained in this manual, nor for any incidents or indirect damages caused by providing, implementing or using this material. HII is not responsible for the softwares or hardwares selected or used in order to achieve the desired results.

The proprietary information contained in this article is protected by copyright. All rights reserved. Without prior written consent from HII, any form of photocopy, copy or translation into other languages is not allowed.

**Trademark Rights**

Android, Google and other marks are trademarks of Google Inc.

Other product names mentioned in this manual may be trademarks or registered trademarks of their respective companies, which are owned by these companies.

**Patents**

For information on patents, please refer to [www.hsmpats.com](http://www.hsmpats.com).

Copyright © 2018 Honeywell International Inc. All rights reserved.

## Contents

Chapter I - Features of ScanPal EDA51-X Enterprise Terminal .....	6
About EDA51-X Terminal.....	6
Battery.....	10
Charging .....	10
Replacing batteries .....	11
Battery icon .....	14
Checking the remaining battery capacity .....	17
Battery life and maintenance .....	17
Battery maintenance recommendations and safety protection measures .....	18
Enabling Airplane mode.....	19
Switch on .....	20
Unlocking the screen .....	20
Scanning Indicator .....	21
Setting screen backlight.....	22
Audio features.....	22
Enabling vibration mode .....	24
Audio settings .....	25
Inserting SD card .....	26
File transfer .....	27
View files on EDA51-X.....	27
EDA51-X Accessories.....	28
Chapter II - User interface and application .....	29
User interface.....	30
Main page .....	30
Navigation and function keys.....	31
Status bar icons .....	31
Key Remap .....	32
Viewing system messages .....	33
Manage system messages.....	33
Personalizing the main interface .....	34
Customizing common applications .....	34
Using Google™ .....	34
Touch screen gestures.....	35
Setting time zone .....	35
Honeywell applications .....	36
GMS.....	37
Chapter III - Scan Function .....	38
Scan Function.....	38
Changing scan settings .....	38
Data processing settings .....	39
Symbology settings.....	41
Imager settings .....	42
Trigger settings .....	42

Notification settings.....	43
Scanning barcodes .....	44
Scan Engine.....	44
Chapter IV - Using Camera .....	45
Camera .....	45
Zooming .....	45
Changing camera settings.....	45
Taking photos .....	45
Shooting videos .....	45
Changing video settings .....	46
Chapter V - Using Telecommunication Function.....	47
Telecommunication Function .....	47
Activating calls .....	47
Making a call.....	49
Answering a call.....	49
Switching applications during a call.....	49
Making an emergency call.....	50
Configuring call settings.....	50
Chapter VI - Configuring Terminal.....	51
Terminal configurations.....	51
Setting launch applications.....	51
Structure of the Application Settings.....	51
Networks& Internet .....	52
Connected devices .....	52
Devices and Google settings.....	53
Honeywell Setting .....	54
System .....	54
Network communication .....	55
Connect to Mobile network.....	55
Connecting to Wi-Fi networks.....	55
Add VPN .....	57
Wireless Security .....	58
Bluetooth communication .....	58
USB Communication .....	58
Near Field Communication (NFC) .....	58
Chapter VII - Management and Maintenance .....	59
Upgrading system software .....	59
Restarting the Terminal.....	60
Restore factory settings .....	61
Chapter VIII - Specifications.....	62
Mechanical and environmental specifications .....	62
Display specifications .....	63
Language Support .....	63
Symbolgies Support.....	63
Scan Depth of Field (DOF).....	65

### **Technical Support**

If you need installation or troubleshooting help, please contact us via:

- Knowledge base: [www.hsmknowledgebase.com](http://www.hsmknowledgebase.com)  
Honeywell knowledge base provides thousands of turnkey solutions. If the knowledge base can't help you solve your problems, you can submit your questions or ask question on Honeywell technical support website.
- Technical support website: [www.hsmsupportportal.com](http://www.hsmsupportportal.com)  
Login Honeywell technical support website to search for knowledge base, submit your difficulties or questions, ask for call-back services or provide feedbacks. Please provide more detailed information when filling the forms. You can also upload attachments for explanation.
- Contacts: [www.honeywellaidc.com/locations](http://www.honeywellaidc.com/locations)  
For the latest contacts, please visit our website.

### **Product Service and Maintenance**

Honeywell International Inc. provide services for all of its products all over the world via its service centers. For information about the site of service centers, please visit [www.honeywellaidc.com](http://www.honeywellaidc.com) and select English as preferred language, then select Support > Contact Support > Service and Maintenance. Please contact our service center to get RMA (Return Material Authorization) numbers before sending the products for maintenance.

To get Honeywell service during warranty or out of warranty, please send the product together with the purchase date records to Honeywell service center (postage paid).

### **Limited Warranty**

For information about the warranty, please visit [www.honeywellaidc.com](http://www.honeywellaidc.com) and select Chinese as preferred language, tap Resources > Warranty.

### **Feedback**

Your feedback is very important for us to improve the quality of documentation. Please contact technical communication departments to submit your feedback on the User Guide:

## Chapter I - Features of ScanPal EDA51-X Enterprise Terminal

ScanPal EDA51-X (X refers to 0 and 1, as in all other cases below) (hereinafter called “EDA51-X” or “terminal”) with Android 8.1 operating system will be introduced in this chapter. Users can learn something about the main features, functions and accessories of this terminal from this chapter.

### About EDA51-X Terminal

Honeywell EDA51-X Enterprise Terminal is a smart phone for enterprise users, delivering stable and secure enterprise data management and wireless communications through Android operating system. The main features of ScanPal EDA51-X are: large-screen display, high-capacity battery, barcode imaging and extreme robustness.

- Android™ 8.1 OS.
- 2 GB dynamic RAM and 16GB flash memory.
- Large display with sensitive multi-touch screen.
- High-performance area imaging features with an ergonomic scan trigger.
- LTE/UMTS/CDMA/GSM wireless WAN communications ensure high-speed data transmission and high-fidelity sound support for all network technologies.
- IEEE 802.11a/b/g/n/ac.
- Bluetooth 4.2.
- Near-field communication (NFC) technology for short-range wireless data transmission.
- High value-added software components support professional imaging and optical character recognition (OCR) features.
- IP64 Ingress Protection.
- Reliable Micro SD slot that supports up to 128GB expansion.
- Integrated GPS receiver.
- 13 mega pixels color camera.

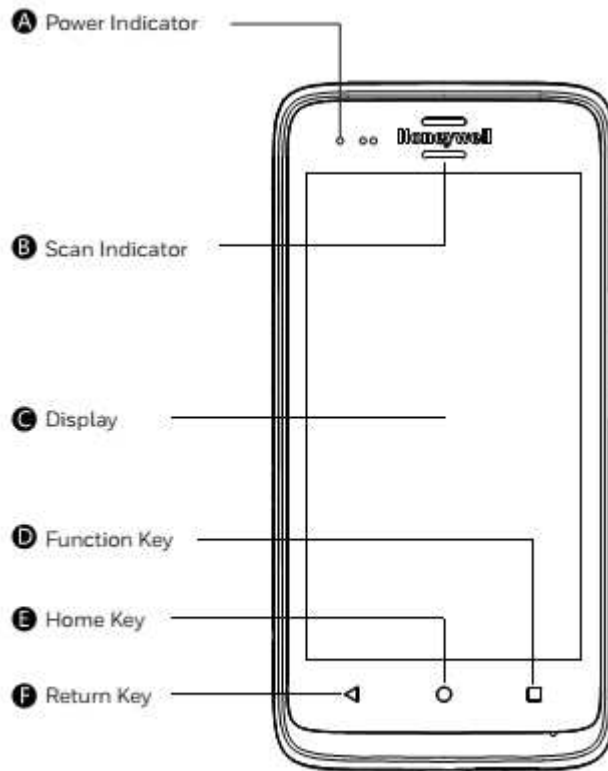

EDA51-X front view

Left Side View

Right Side View

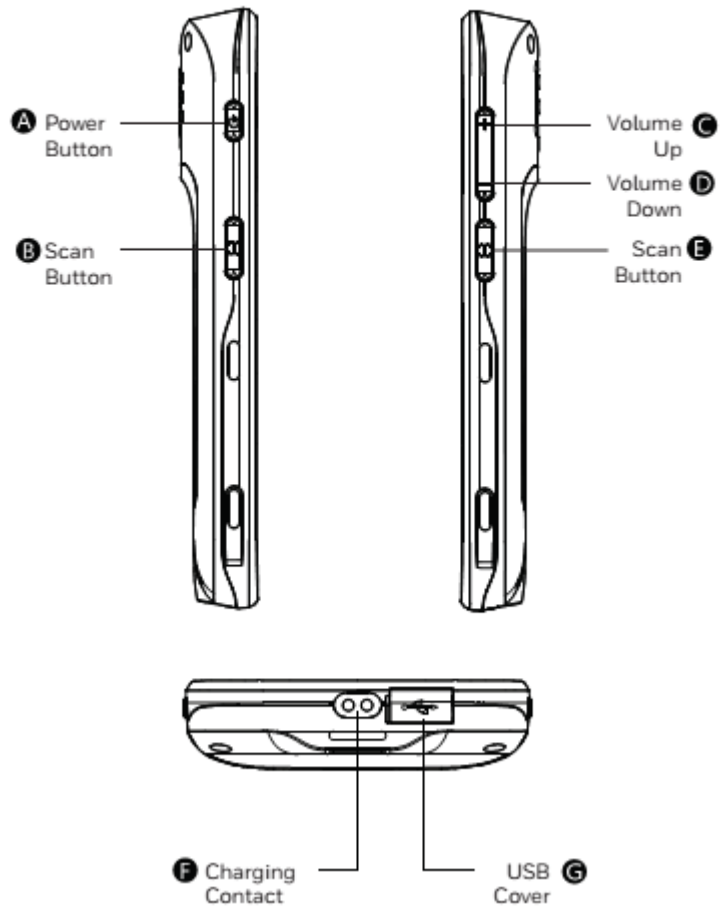

EDA51-X side and bottom views



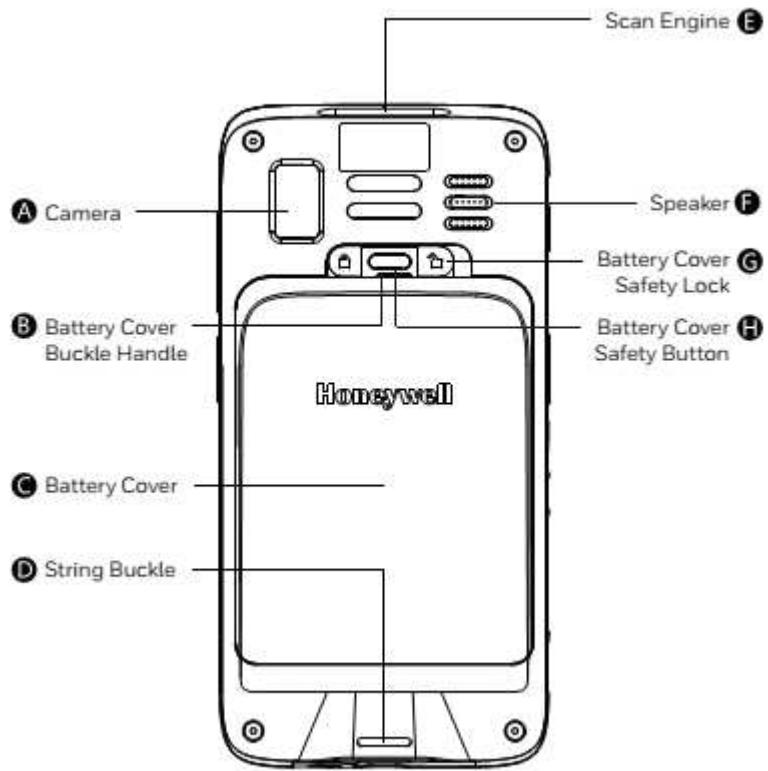

EDA51-X rear view

## Battery

EDA51-X uses 3.8V rechargeable lithium ion battery as its main power supply. The battery capacity is 15.2 watt/hour. Battery life is influenced by many factors, such as: screen brightness, the length of time before the screen automatically go to sleep, input configurations, extreme temperature and using behaviors, etc.

Honeywell suggests you to keep the battery charged to avoid data loss. Change battery only after switching off the device as per normal. Switch on the device after completing change of battery.

If you need to buy a replaceable battery, please contact regional resellers.

We would recommend using only Honeywell's lithium battery; any damage caused by use of non-Honeywell battery is not covered by warranty.

### **Warning:**

- ***Improper use of the battery of this device can cause a fire or chemical burns. Please don't disassemble the battery or heat it to 100 °C (212 °F) and above, or incinerate the battery. Make sure waste batteries are properly disposed. Keep out of reach of the children.***
- ***Do not store the battery without using for a long time. If store the battery for over 3 months, please make sure check the remaining battery power capacity over 30% every 3 months.***

## Charging

Before using EDA51-X, you need to make sure the battery (model number: BAT-EDA50) is fully charged. You can charge the battery before or after installing it to EDA51-X. It will take about 5 hours for the battery to be fully charged using original charger, quad bay charger, single cradle charger.

We would recommend using Honeywell's original charger; any damage caused by use of non-Honeywell charger is not covered by warranty

P10

## Replacing batteries

When the battery power is low, you can charge it together with the terminal, or replace it with a fully-charged battery.

1. Save all the files and close all running Apps.
2. Long press the **power** button. Until the follow interface pop up:

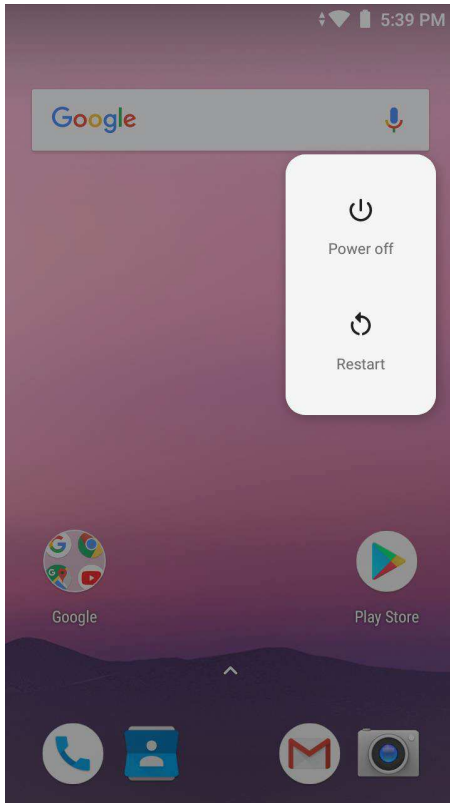

3. Tap **Power off**.
4. EDA51-X will power off directly.

5. After it's powered off, do as the following instructions manually:
  - 1) Press down the battery cover safety button to move the lock to the unlock position at right;

1

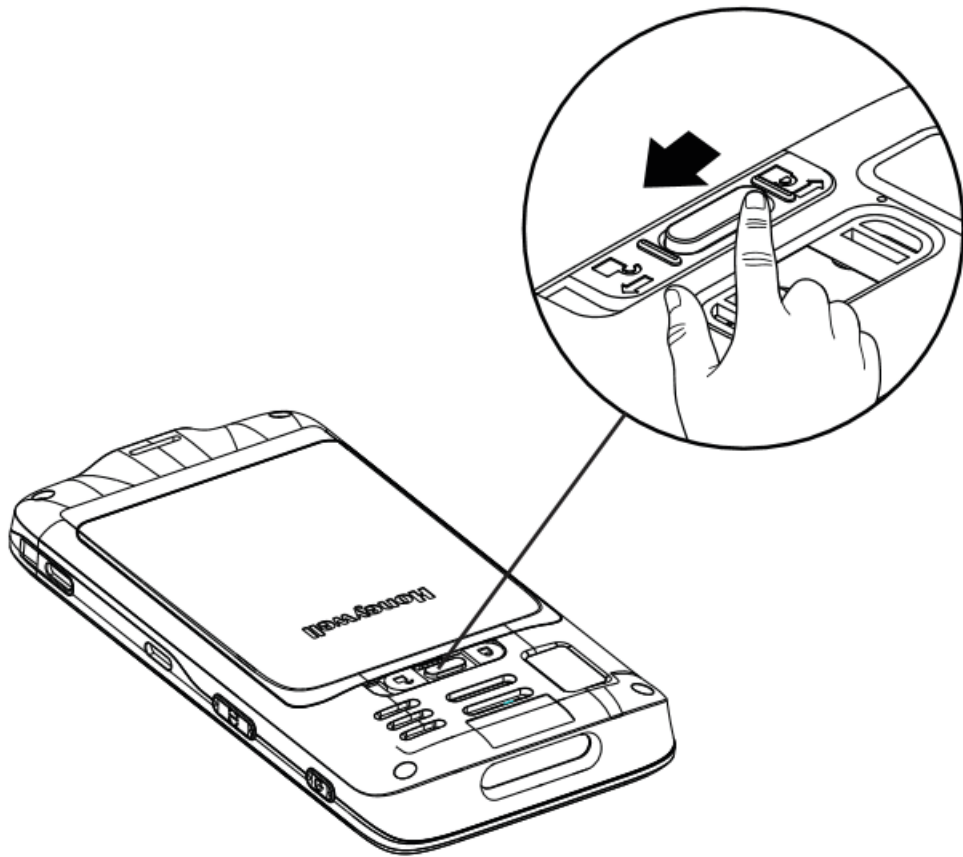

- 2) Open the battery cover with the battery cover buckle handle;

2

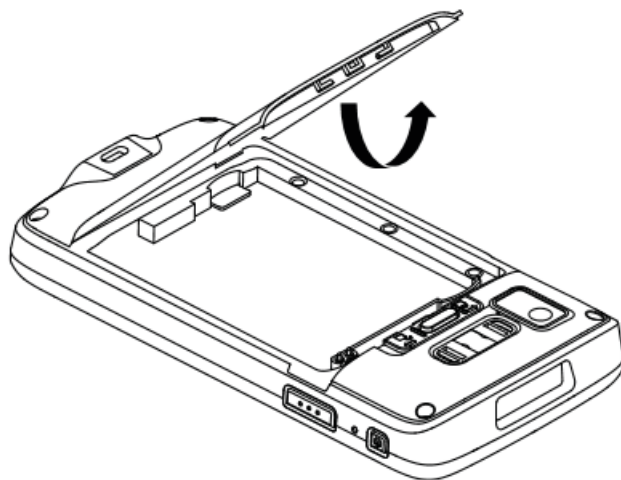

- 3) Insert the battery (Insert the non-connector side first, then press the battery down to establish connection between the battery and the phone);

**3**

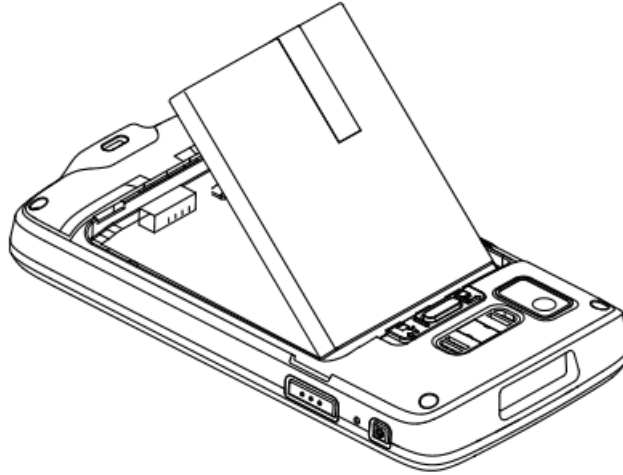

- 4) Press down the battery cover;

**4**

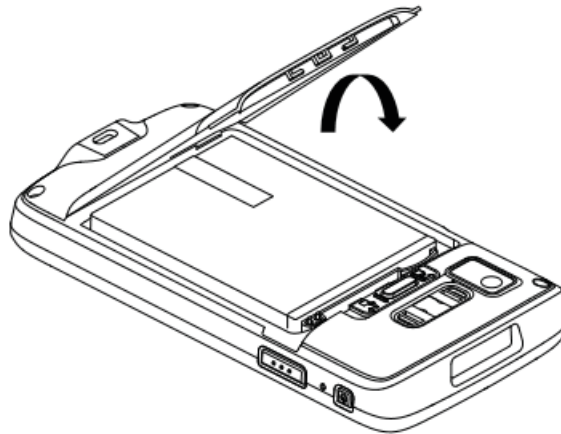



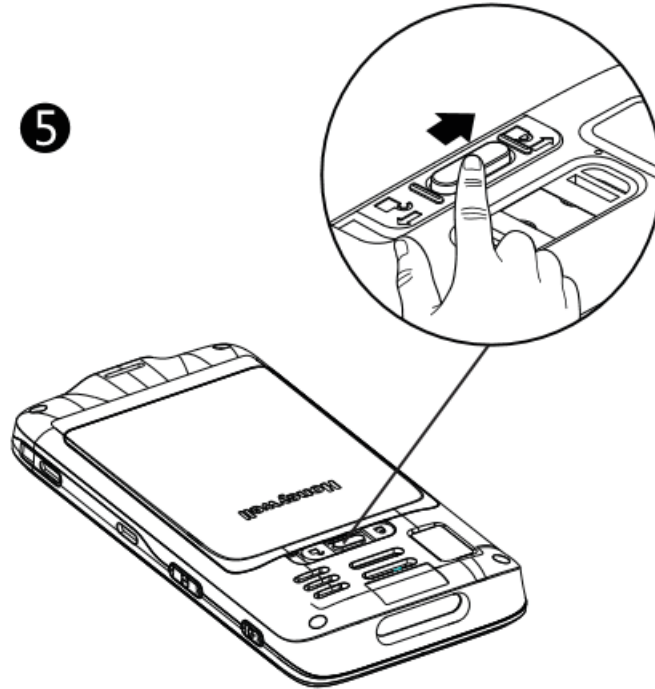

- 5) Press down the battery cover safety button to move the battery cover safety lock to the lock position at left.



### Battery icon

Battery icon on the status bar shows the power status of the battery. The following table only contains several of the icons. For detailed information about battery life and power remained, please go to **Settings > Battery**.

Battery icon

Icon	Status
	Battery power is 100% full
	Battery power is 50% full
	Battery power is too low. Replacing the battery right now.
	The terminal has been connected to external power supply for charging.
Power indicator LED flashing red	Battery failure occurs. Please replace the battery. If the failure still exists, please contact Honeywell technical support.

## P17

Power indicator on the upper left corner of the terminal shows the battery charging status. It can also be used as system message indicator. For detailed setting methods, please refer to <http://developer.android.com/guide/topics/ui/notifiers/notifications.html>.

Default power indicator description

<b>Connect to power supply</b>	<b>Indicator status</b>	<b>Description</b>
No	Flashing amber (Orange)	Battery power is less than 15% full
No	No light	Battery power is higher than 15% full
Yes	Stable amber (Orange)	Battery power is between 0% to 60% full
Yes	Flashing green	Battery power is between 60% to 95% full
Yes	Stable green	Battery power is higher than 95% full
Yes/no	Flashing red	Battery failure

**Changing power indicators**

If the default indicators for battery charging (flashing green) are inappropriate for your environment, you can change the indicator.

In addition to changing the default power indicator, you can also select:

- Default Battery LED
- No Battery LED

If you prefer the indicator to be solid amber and to change to solid green when in charging, you need to perform **Default Battery LED** settings. If you prefer the indicator as message notification (application or device management solution notification) indicator, you need to select **No Battery LED** settings.

Default power indicator meanings

<b>Connect to power supply</b>	<b>Indicator status</b>	<b>Description</b>
No	Flashing red	Battery power is less than 15% full
No	No light	Battery power is 15% or more
Yes	Stable red	Battery power is less than 15% full
Yes	Stable amber	Battery power is between 15% to 90% full
Yes	Stable green	Battery power is over 90% full

1. Tap **Settings> Honeywell Settings>Battery LED**
2. Select from the following options:
  - a. Default Battery LED
  - b. Honeywell Battery LED (Factory default settings)
  - c. No Battery LED



## Checking the remaining battery capacity

Except for the battery icon and power indicator, you can also get the battery capacity information from Settings.

1. Tap **Settings**
2. Tap **Battery**. The current percentage of remaining battery capacity and the remaining time will be displayed. The list will present the power consumed by each application and service. For detailed usage information, please tap the respective applications and services in the list.

## Battery life and maintenance

The battery will discharge slowly if it's placed outside of the terminal. Honeywell technical support recommends you store battery in a charger to maintain battery performance.

Tips for battery maintenance

If you have the following needs:	Power saving plan:
Low power icon shows on the screen or the power indicator lights on when the terminal is in use	Long press the power button and choose Turn Off. And the replace the battery with fully charged one.
The terminal will not be in use for 5 mins or more	Make sure no low power icon displayed and the power indicator doesn't light on. Switch to sleep mode by pressing the <b>Power button</b> .
The terminal will be stored for more than one day	<ul style="list-style-type: none"> <li>• If you need to store this terminal for several days (like a weekend), you need to install a fully charged battery or connect the terminal to the power supply.</li> <li>• If you need to store it for a longer time, remove the battery and charge it. Put the terminal and the battery in a shady and cool place after the battery is fully charged.</li> <li>• If the battery is to be stored for several months, regular charging is needed for excellent battery performance.</li> </ul>
Store the battery outside the terminal	Put the battery in the charger.

## **Battery maintenance recommendations and safety protection measures**

- Fully charge the battery before using it. The battery is only partly charged when get packed.
- Refer to the chapter "charging" to get the right process for battery charging. Using the battery for other devices may cause damages on the device or the battery.
- Avoid battery or terminal drops. If you suspect that a battery or terminal fails, send it to Honeywell service center for verification.
- This battery can only replace another BAT-EDA51-X battery. These batteries have been tested and meet the appropriate safety standards. If you need to replace the battery, please contact Honeywell service representatives or the resellers.
- There are security risks in waste batteries. Before cleaning up the battery, stick the poles with insulation tape.
- Do not modify the battery or attempt to insert foreign objects into the battery.
- Do not solder directly to the battery poles.
- Do not short connect the battery and put the battery away from metal objects.
- Do not drop or mechanically shock or extrude the battery.
- Do not disassemble or open the battery. Do not crush, bend or deform the battery; Do not puncture, shred or burn the battery.
- Do not immerse the battery in water.

P21

## **Enabling Airplane mode**

If you don't need to connect to any wireless network, you can enable the airplane mode to turn off all wireless receivers to save power.

1. Tap **Settings**.
2. Tap **Network & Internet**.
3. Open Switch control of **Airplane Mode** to enable airplane mode.

P22

## Switch on

After the battery is fully charged and installed into EDA51-X, switch on it for the first time:

Press down and then release the **power button**.

Please note: after complete the installation instructions, the welcome interface will not appear again. The interface appears as locked screen interface after each time you switch on the terminal.

## Unlocking the screen

Every time you switch on the EDA51-X, you need to unlock the screen.

- Slide the lock icon to any edge of the screen to unlock it.
- After the EDA51-X is deployed, we suggest you to set password to protect your terminal.

Tap **Settings>Security&Location>Screen lock**.

Available options: **None, Swipe, Pattern, PIN and Password**



## Scanning Indicator

The scanning indicator indicates the status of the scanner. For barcode scanning method, please refer to the chapter "Scanning barcodes".

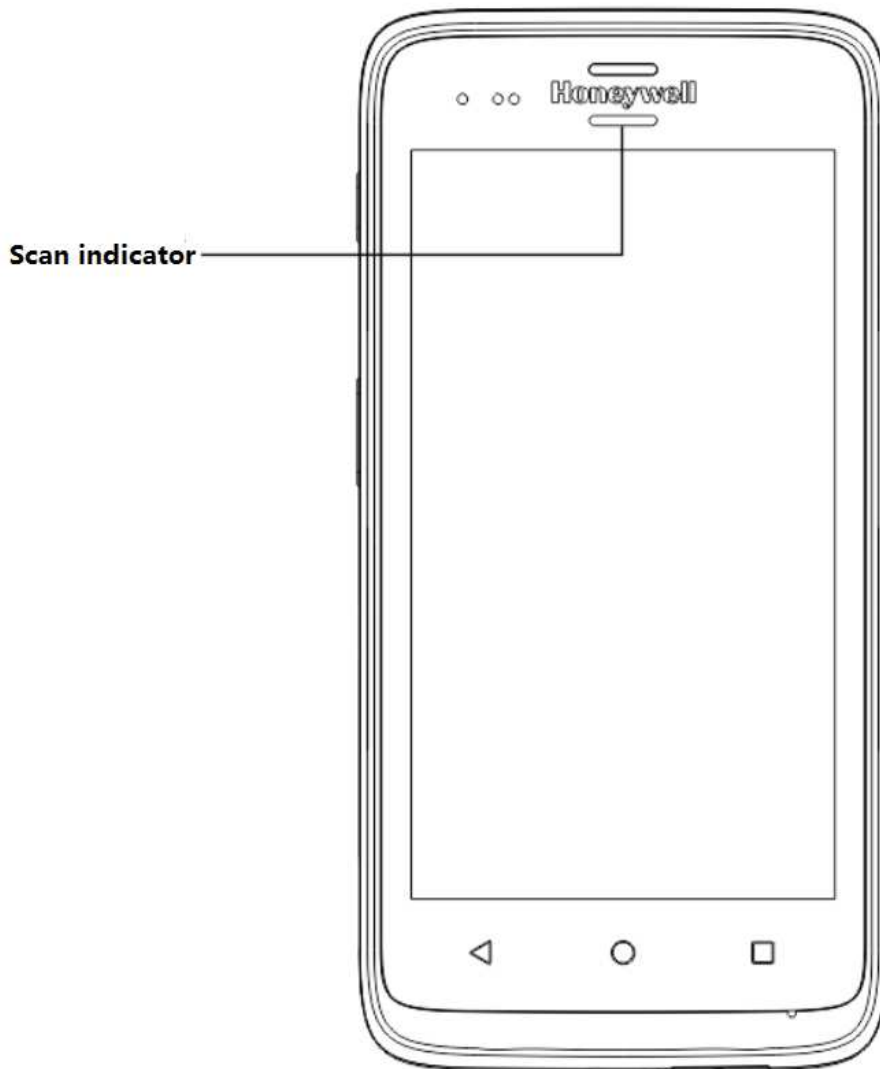

Scanning indicator definition

Light of the indicator	Meanings
Green	Good read for the barcodes
Red	Barcodes reading failed

## Setting screen backlight

The terminal's screen is equipped with background light sensor which can automatically adjust backlight intensity to save power and ensure the display readability. You may set the backlight intensity based on the environment.

1. Tap **Settings**.
2. Tap **Display>Brightness level**
3. Tap **Adaptive brightness** to automatically adjust the backlight intensity, or slide adjustment bar to set the backlight intensity.

## Audio features

EDA51-X is equipped with speaker, receiver and software utilities for volume setting.

Adjusting the ringtone volume for calls and messages

With the volume key on the side of the terminal, you can quickly adjust the ringtone volume.

Note: Volume key can only adjust ringtone volume for calls and messages. To adjust volumes of other sound, open

**Settings >Sound**.

P25

1. Press the key on the right side of the terminal (+ or-). Volume bar will show on the screen.
2. Adjust the volume by pressing volume key or slide volume bar.
3. Hold down the volume down (-) button or pull the volume indicator to the extreme left to activate vibration mode.

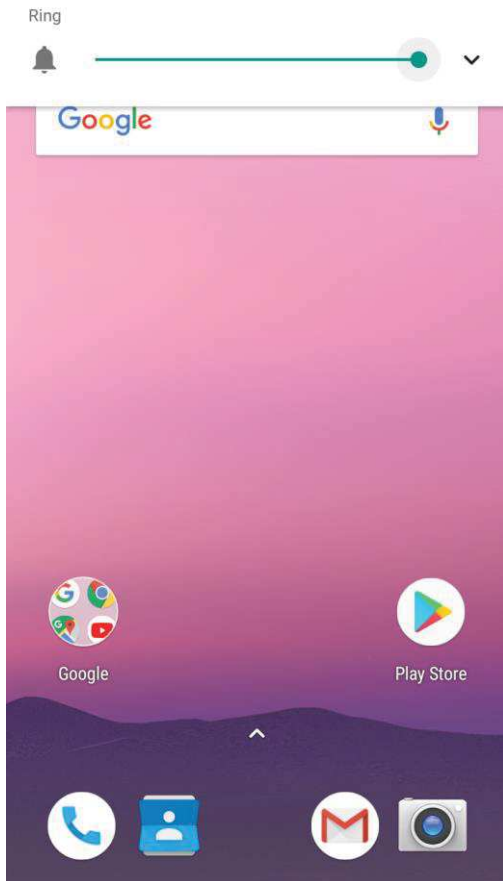

P26

## Enabling vibration mode

You can set the terminal to vibration/silence mode in the office.

Hold down the volume down (-) button or pull the volume indicator to the extreme left to activate vibration mode.

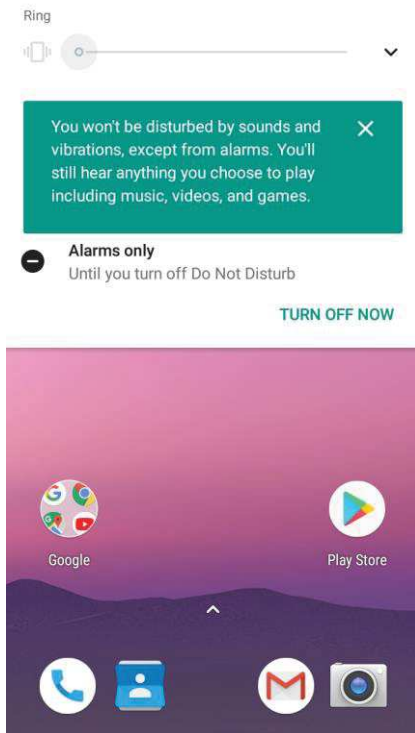



## Audio settings

This chapter will describe about audio and sound settings. To change audio setting, go to **Settings > Sound**.

### Audio and sound settings

Settings	Description
Media Volume	Use the volume adjustment bar to set the volume for: Music, videos, games and other medias.
Alarm Volume	Use the volume adjustment bar to set the volume for: Alarm and alert tones
Notification Volume	Use the volume adjustment bar to set the volume for: notification tones
Do Not Disturb preferences	Could adjust do not disturb rules
Default notification sound	Select notifications tones
Default alarm sound	Select alarm ringtone
Other sounds and vibrations	Set whether to turn on: lock screen sounds, charging sounds, touch sounds, and Vibrate on tap.

## Inserting SD card

You can use a SD card to expand the memory or to install softwares. Honeywell recommend the using of Single Level Cell (SLC) graded SD memory card or SDHC memory card in order to achieve optimum performance and durability.

**Note:** *format the memory card when you use it for the first time.*

1. Turn off the terminal.
2. Press down the battery cover safety button to move the lock to the unlock position at right;
3. Open the battery cover with the battery cover buckle handle;
4. Pull out the battery (First open the battery connector side, then pull out the battery)
5. Open the Micro SD card's silicone cover;
6. Open the Micro SD card cover and insert the card;
7. Insert the battery (first insert one end before pressing the other end in order for it to be connected to the device);
8. Press to lock the battery cover
9. Press down the battery cover and slide the battery cover buckle handle to lock it.
10. Switch on the device

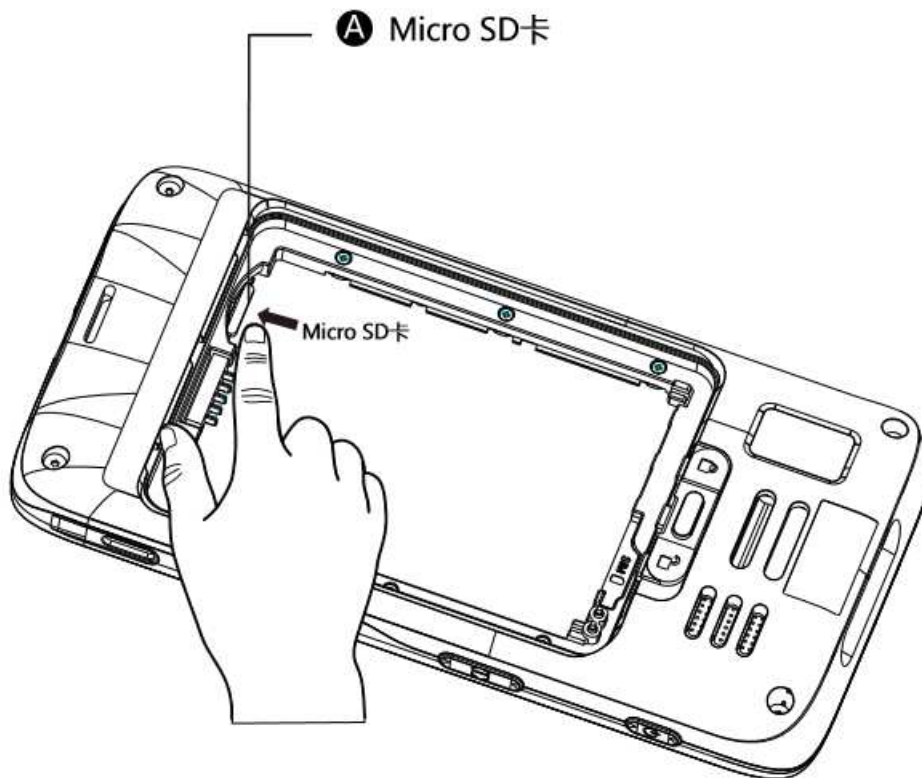

Micro SD Card

## File transfer

Files can be transferred between the terminal and a computer by using a USB adapter or standard USB cable. By connecting the terminal to a computer with a USB cable, you can view the files in the terminal, or transfer the files to the computer, or transfer files from the computer to the terminal. If you transfer files with a Mac computer, you need to use Android File Transfer app (it can be download via [www.android.com/filetransfer](http://www.android.com/filetransfer))

The terminal will connect with charging port as default and support MTP (Media Transfer Protocol) or PTP (Picture Transfer Protocol). If you mainly transfer camera photos, you can use PTP connection settings. If the computer with Windows system doesn't support MTP, you can use PTP transmission.



Follow below steps:

1. Connect EDA51-X to the computer.
2. Select Media device (MTP) or Camera (PTP) on the EDA51-X screen. EDA51-X will set your selection as default selection.
3. View the files stored in EDA51-X. You can copy, delete or transfer the files between EDA51-X and the computer.

**Note:** *EDA51-X supports high-speed USB communication (USB2.0), with maximum data transfer rate at 480 Mbps.*

## View files on EDA51-X

Users can view the files in EDA51-X and its memory card through File Explorer.

1. Tap or pull upward  > File manager  文件管理器.
2. Tap the folder name or file name to open the file.

**Note:** *Due to system permission issues, some files cannot be opened. Based on your needs, you can select respective apps to open the file.*

**EDA51-X Accessories**

EDA51-X terminal is equipped with original battery. All other accessories require separate order and shipment. If necessary, please contact your local sales representatives.

For EDA 51-X accessories and description, please see below table:

<b>Item</b>	<b>Description</b>
EDA51 home base	Charging one EDA51 terminal and EDA51 battery simultaneously
EDA51 single cradle	Charging one EDA51 terminal
EDA51 quad charging base	Charging four EDA51 terminal simultaneously
EDA51 quad battery charging base	Charging four EDA51 battery simultaneously
EDA51 scan handle	Working with EDA51 terminal, easy to hold and scan
EDA51 hand strap	EDA51 reserve buckle for hand strap
EDA51 Micro USB to 3.5mm audio adaptor	EDA51 Micro USB to 3.5mm audio adaptor provide audio port for CTIA standard wire headset.

## **Chapter II - User interface and application**

This chapter introduces the Android system user interface, and how to interact with the screen. Users can also learn about a variety of Honeywell applications on the terminal through this chapter.

## User interface

Android 8.1 operating system user interface provides users with a perfect touch and easy navigation experience.

### Main page

After switch on the terminal and setting up your preferred language, the main page will be displayed on the screen first.

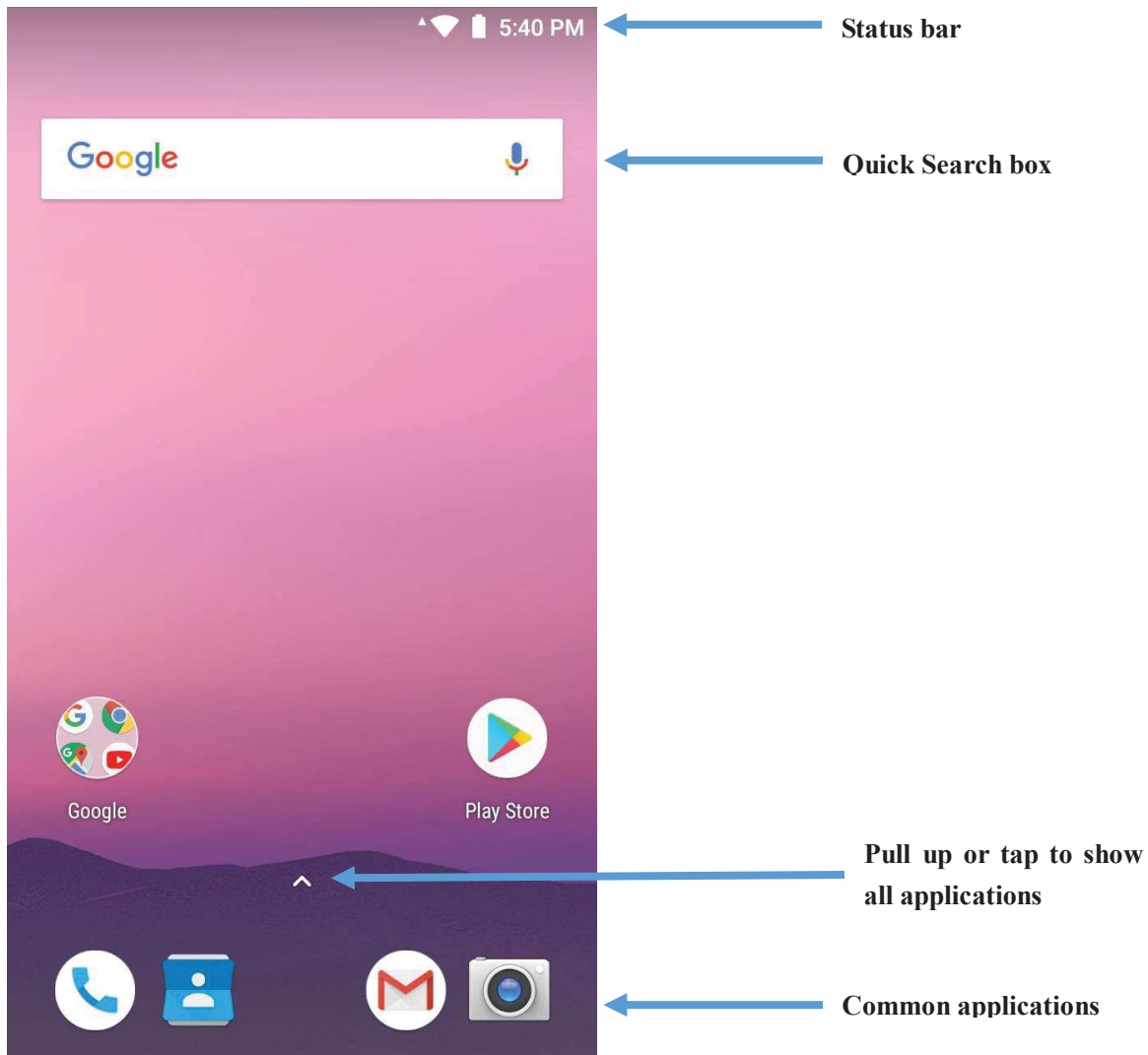







### The main page description

Name	Description
Status bar	The left side of the status bar displays system messages sent by the application, such as information notifications. The right of the status bar displays the current wireless and network connection status and remaining battery power.
Common applications	The applications on this bar will be displayed on the main interface.
Search bar	Use Google Search to search on the web or the terminal.

## Navigation and function keys

There are navigation and function keys below the common applications in the main interface of EDA51-X; other function keys are on the two sides of the terminal.















### Navigation and function keys

Keys	Description	Functions
	Return	Return to the previous screen
	Function Key	Show the applications that have been visited recently
	Home Key	Return to the main interface
	Volume	Increase or decrease the speaker volume
	Scan Button	Press and hold to scan graphics
	Power button	Turn on, turn off, lock the screen

## Status bar icons

Status and notification icons display the current network connections, power, notifications and sound settings. Please refer the following table for detailed status bar icons:

### Status and notification icons:

Icons	Description	Icons	Description
	Incomplete calendar events		Sound is disabled
	Not ringing alarm clock; alarm clock set		Vibration mode has been enabled
	New text messages or multimedia information		Battery power is 100% full
	Text messages or multimedia information transmission failed		Being in charge with external power supply
	New mails		Airplane mode is enabled
	Memory card is full		EDA51-X is syncing with a Bluetooth-enabled device
	EDA51-X is syncing with a Bluetooth-enabled device		Wi-Fi is connected, but with no signal
	Network connected		Wi-Fi signal is adequate

## Key Remap

1. Tap **Settings** > **Honeywell Settings**>**Key Remap**.
2. Touch the +
3. Click keys you want to redefine.
4. Tap **KEYS** or **APPs** to view options.
5. Select the required functions for the key. The new functions selected will be displayed under the name of the key.



## Viewing system messages

Users can view EDA51-X's system messages in the notification page.

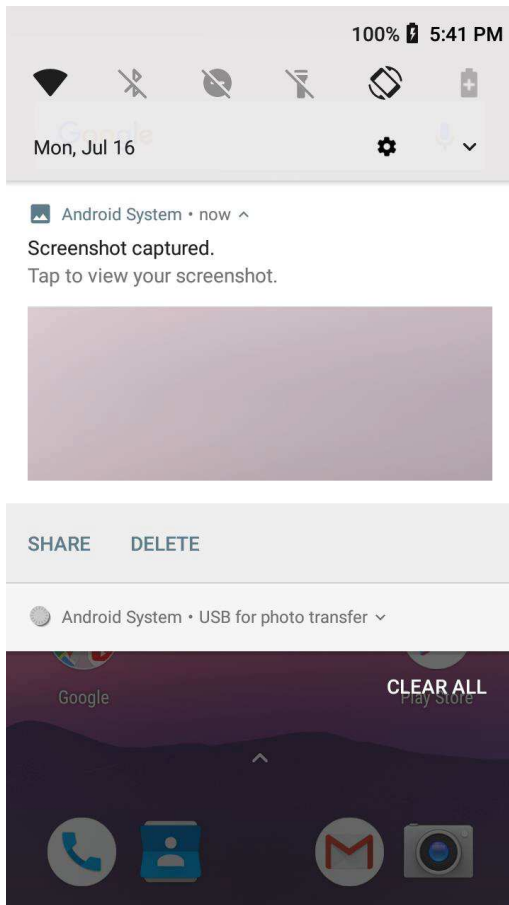

- Open the notification page: swipe down from the top of the screen.
- Close the notification page: swipe up from the bottom of the screen or tap **Return key** or **Home key**.

## Manage system messages

When the applications send system messages to EDA51-X, users can manage them quickly.

1. When the system message icon appears, swipe down the screen.
  2. To manage the system message, touch it. The respective application will be opened for users to manage it.
- Swipe the system message to the side to clear it.
  - Slide the message to the left to set it.

## Personalizing the main interface

You can add application icons to either one of the main interface to open these applications more quickly.

1. Tap or pull upward . To display **All applications**.
2. To move the application icon to the main interface: long press the icons to be added to the main interface, then slide your finger to place it on either one of the main interface.  
To move the application icon to the main interface: long press the desktop- > widget- >long press the widget icon, then slide your finger to place the control icon on either one of the main interface.
3. To remove the applications or widgets from the main interface: long press the icons and slide to **X Delete** on the top of the interface.
4. Long press the blank area on the desktop, and display menu **WALLPAPERS, WIDGETS** and **SETTINGS**.

## Customizing common applications

Users can add applications to the common application bar to open these applications more quickly.

1. Tap or pull upward . To display **All applications**.
2. Long press the icons in the common application bar and slide it to the X Delete on the top of the interface.
3. To add application icon to the common application bar: long press the application to be added to the main interface, then slide your finger to place it in common applications.

## Using Google™

Use Google search engine at the top of the interface to help users find any information on the terminal or the internet.

1. In any of the main screens, tap Google search box and enter search object. The search results on the terminal (such as applications and contacts) will also appear on the network search result.
2. Tap a search prompt to start the search now, or simply tap the arrow to enter it into the search box without searching immediately.



**BSR idware GmbH**

Jakob-Haringer-Str.3

A-5020 Salzburg

<https://www.bsr.at>

[sales@bsr.at](mailto:sales@bsr.at)

## Touch screen gestures

Use your finger can operate applications, menus, on-screen keyboard and other functions on the interface.

- Tap a function or application to select or start it.
- To enter a name or password, touch the place to enter and on-screen keyboard will appear for input.

### Other touch screen gestures include:

- Long press: press an icon and hold until the system reacts.
- Drag: Press an icon, and then move your finger across the screen to the destination. For example: With dragging method, you can rearrange some shortcuts on the main interface.
- Swipe or slide: Quickly move your finger on the screen and keep your finger touching on the screen. For example, users can swipe the home screen to the left or right to view other home screens.
- Double-click: tap twice rapidly in a row on the map or other interface to enlarge it. Double-click again to return to the original size.
- Kneading: In some applications, subjects can be zoomed out by kneading two fingers on the screen, or zoom in by expanding two fingers.

## Setting time zone

EDA51-X can automatically sync the time and date according to the network. Users can also set time zone for their regions manually.

1. Tap **Settings>System**.
2. Tap **Date & Time**.
3. Uncheck **Automatic date & time**.
4. Tap **Selecting Time zone** and tap the time zone for your region.

## Honeywell applications









Honeywell helps users troubleshoot and connect the terminals to other devices and networks. Tap or pull upward

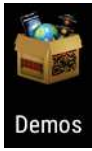

to show the applications below. For more details, please visit:

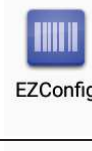
[www.honeywellaidc.com](http://www.honeywellaidc.com).

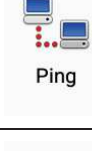
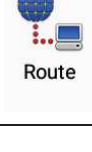
### Honeywell software applications available on EDA51-X

Icons	Applications	Descriptions
 Demos	Demos	Scan Demo, NFC Demo and more included, allows testing and using functions like Scan Demo and NFC.
 Configure Autorun	Configure Autorun	Autorun application when the device is being activated
 BattMon	BattMon	Monitors battery-charging status
 Diagnostic Information	Diagnostic Information	Check equipment information, Honeywell applications, radio frequency information, RAM and scanner
 EZConfig	EZConfig	Configure equipment and applications through barcode and configuration documents
 IPConfig	IPConfig	View and set IP address
 Ping	Ping	Network diagnostic tool to test whether the network is connected
 Route	Route	View routing information
 Wire-lessTether	Wire-lessTether	Display the paired Bluetooth set, if the paired BT set move out of range, the terminal will alarm

### **Download Enterprise Application Lock (Applock)**

Honeywell Applock is an Android application which allows you to configure the apps that may or may not be allowed. The User Guide and installation procedure for Applock may be downloaded via: [www.honeywellaidc.com](http://www.honeywellaidc.com)

### **Unlocking developer options**

If you are a developer for EDA51-X, you can easily unlock developer options. Developer options can help you test and troubleshoot during the process of developing EDA51-X. After Developer options is unlocked, the system menu will present developer option connections.

1. Tap **Settings**.
2. Tap **System**
3. Tap **About phone**.
4. Click the Build number 7 times and notification as "You are now in developer mode" will appear.

### **GMS**

EDA51-X joined in GMS packages of Google.

The App includes Google, Chrome, Gmail, Maps, YouTube, Drive, Play Music, Play Movies, Duo, Photos, Play Store.

## Chapter III - Scan Function

This chapter describes how to scan barcodes and set scan functions.

### Scan Function

Integrated scanner enables reading for 1D and 2D barcode, composite code and postcode. It supports comprehensive, highly flexible scanning in real applications. Imaging Engine can capture black and white images, such as signatures and damaged inventory lists.

How to transfer data via Android keyboard input?

Scan wedge feature enables transferring scanned barcode data to active applications via Android keyboard input. Scan wedge function is enabled by default on EDA51-X. Users can use applications that can accept scan wedge function through scanners or applications. If an application obtains scan function through Barcode Reader API, the scan wedge function will be temporarily disabled.

Users can build customized applications in Software Development Kit (SDK) for EDA51-X. Please download SDK at: [www.honeywellaidc.com](http://www.honeywellaidc.com).

### Changing scan settings

Changes made to the default file apply for all non-document applications.

1. Tap **Settings**.
2. Tap **Honeywell settings**
3. Tap **Scan Settings**.
4. Tap **Internal Scanner**
5. Tap **Default profile**.
6. Select **Data Processing Settings, Symbology Settings, Decode Settings, Imager Settings, Trigger Settings or Notification Settings**.
7. Modify the setting to meet application needs.

**Restoring default scan settings**

Users can easily cancel all the changes made to default folder and restore the factory defaults.

*Note: Restore factory defaults for a certain setting, all the settings under this folder will be restored to factory defaults.*

1. Tap the  icon on the upright of any Scan Settings interface.
2. Tap **Restore all defaults**.

**Scanner default settings**

Study the following table to learn about Data Processing Settings, Symbology Settings, Decode Settings, Imager Settings, Trigger Settings and Notification Settings.

Data processing settings

Use data processing settings to set the barcode data processing patterns for EDA51-X.

**Data processing settings**

Settings	Description	Default
Wedge	Enable or disable the transferring of barcode data as Android Events when sending data to the application.	Enabled
Charset	Explain the selected character set when the barcode is a character, options including: <ul style="list-style-type: none"> <li>• ISO-8859-1</li> <li>• US-ASCII</li> <li>• UTF-16</li> <li>• UTF-16BE</li> <li>• UTF-16LE</li> <li>• UTF-8</li> </ul> The related BarCodeReader attributes: PROPERTY_DATA_PROCESSOR_CHARSET	ISO-8859-1
Prefix	Define the character to be added in front of the decoding barcodes	No
Suffix	Define the character to be added at the end of the decoding barcodes	No
Data editing plugin	Specify a free plug-in for data editing	No
Symbology prefix	Specify a Symbology prefix to decode the barcode data <ul style="list-style-type: none"> <li>• None</li> <li>• Honeywell</li> <li>• AIM</li> </ul>	No
Launch Browser	To open or close URL barcode, if the barcode start with http:// or https://, the browser will open the respective URL  The related BarCodeReader attributes: PROPERTY_DATA_PROCESSOR_LAUNCH-BROWSER	Enable
Scan To Intent	Enable or disable scan processing for specified targets. Apply the barcode as the following	Enabled

	<p>format</p> <p>‘/’ ACTION</p> <p>‘/’ intent-suffix ‘\$’ extra-data</p> <p>Where:</p> <p>Additional operations and data include the following characters, to enable Intent or respective applications</p> <p>Intent action: “com.honeywell.scantointent.intent.action.”+ ACTION</p> <p>Intent extra “com.honeywell.scantointent.intent.extra.DATA ” contains the remainder of the bar code data after the first ‘\$’ character.</p> <p>The related BarCodeReader attributes:</p> <p>PROPERTY_DATA_PROCESSOR_SCAN_TO_INTENT</p>	
Launch EZ Config	<p>Enable or disable specifying EZ Config operations to barcode. Adopt Aztec code and include specified header data.</p> <p>The related BarCodeReader attributes: PROPERTY_DATA_PROCESSOR_LAUNCH_EZ_CONFIG</p>	Enabled
Data Intent		NO



## Symbology settings

Enable or disable a barcode symbology with Symbology Settings. Tap on a symbol to view and modify the configuration parameters of the symbol.

### Symbology settings

Settings	Default	Settings	Default
Code 128	Enabled	GS1 Databar	Disabled
GS1-128	Enabled	Han Xin	Disabled
Code 39	Enabled	IATA 2 of 5	Disabled
Datamatrix	Enabled	Interleaved 2 of 5	Enabled
Grid Matrix	Disabled	Korean Post	Disabled
UPC-A	Enabled	Matrix 2 of 5	Disabled
UPC-E	Disabled	Maxicode	Disabled
EAN-8	Disabled	Micro PDF 417	Disabled
EAN-13	Enabled	MSI	Disabled
Aztec	Enabled	PDF 417	Enabled
China Post	Disabled	QR Code	Enabled
Codabar	Enabled	Standard 2 of 5	Disabled
Codablock A	Disabled	Telepen	Disabled
Codablock F	Disabled	TLC 39	Disabled
Code 11	Disabled	Trioptic	Disabled
Code 93	Disabled	2D Postal Settings	Disabled
Composite	Disabled	OCR	Disabled
Dotcode	Disabled		

## Imager settings

There should be no need for users to change image color rendering. **Override Recommended Values** is disabled by default. Recommended image settings can be applied in many environments; only the users who have more in-depth understanding on the image can change the settings.

## Trigger settings

Trigger settings can set up the using patterns for scan key.

Settings	Description	Default
Enable Scan trigger	Enable or disable scan trigger	Enabled
Scan delay	Set the start scanning delay time	0
Decoding timeout	If the scan trigger is held down but decoding is not successfully performed, Scanning will automatically shut down after 20 seconds	20
Trigger Scan mode	Set the scan mode: <ul style="list-style-type: none"> <li>• One shot</li> <li>• Continuous</li> <li>• Read on release</li> <li>• Read on second trigger press</li> </ul>	One shot
Same Symbol timeout	If the scanner continue to scan the same code, it will automatically shut down after the set times.	Disabled

**Notification settings**

You can set up the responses during scanning process for EDA51-X in the notification settings.

## Notification settings

<b>Settings</b>	<b>Description</b>	<b>Default</b>
Good Read Notification	Enable or disable Good Read Notification. Notification includes green indicator, short beep and optional short vibration	Enabled
Bad Read Notification	Enable or disable Fail to Read notification. Notification includes red indicator, failure beep and optional short vibration	Disabled
Vibrate On Notification	Regardless of succeeding or failing to read, turn on or off the phone vibrations	Disabled

## Scanning barcodes

Scan engine will emit scanning beams for accurate barcode aiming. It will also support a full range of 360° scanning, which will make barcode scanning more convenient.

1. Tap or pull upward  >Demos>ScanDemo.
2. Align the scanning window with the barcode and stably place the terminal a few inches away from the barcode.
3. Press one of the scan keys or tap **Scan** on the interface. Make sure the entire barcode is within the scanning beam range.
4. When the scanning is successfully completed, you will hear a "beep" sound, and the Good Read LED will open immediately.

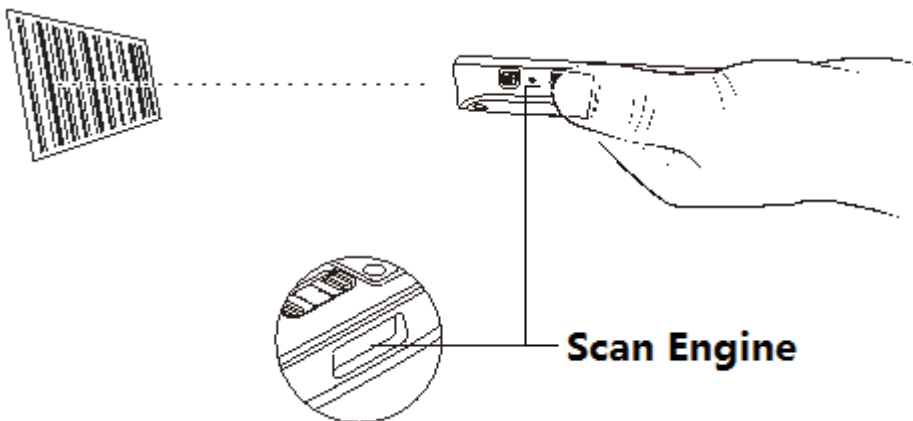

*Note: Before scanning a barcode, you need to enable the desired barcode Symbology in the settings.*

## Scan Engine

EDA51-X equips Honeywell N6603 scan engine.

The N6603 series integrates Honeywell's Adaptus 6.0 technology for unparalleled 1D and 2D scanning performance.

Items	Performance
Sensor	Proprietary CMOS sensor with global shutter and 844 x 640 pixel resolution
Illumination	White LED (exempt risk group)
Aiming	650 nm high-visibility red laser (class 2 laser safety)
Typical frame rate	60 frames per second (max.)
Motion Tolerance	Up to 584 cm ( 230" ) per second in total darkness with 100% UPC at 10 cm ( 4" ) distance
Field of View	Horizontal Field Angle: 42.4° /Vertical Field Angle: 33
Scan Angles	Tilt: 360°, Pitch: ± 45, Skew: ± 60°
Symbol Contrast	20% minimum reflectance

## Chapter IV - Using Camera

This chapter describes how to use the camera to take photos and videos.

### Camera

EDA51-X is equipped with a 13 MP color camera which can be used to take photos and videos. The camera and flash light are located on the back of the terminal. Tap **Photos**  app to view all the photos and videos stored on the terminal.

**Adjust the camera and video settings in the Camera apps.**

### Zooming

Focus adjustment is realized by zooming actions of the fingers on the screen. Place two fingers on the screen at the same time, then:



- Separate the two fingers in opposite directions to zoom in the images (enlarge objects).
- Fold the two fingers in opposite directions to zoom out the images

### Changing camera settings

In order to obtain the best results when taking photos, users can change the camera settings beforehand.



1. Tap All Applications and then tap Camera .
2. Tap the Setting icon on the top right to view Camera Options.
3. Tap HDR or any icons to change the basic settings of the camera.
  - When HDR is enabled, the terminal will automatically capture multiple photos and composite them into one to achieve the best possible image quality.
  - Enable or disable various options, like viewfinder mode, storage location and image size.



### Taking photos

1. Tap All Applications and then tap Camera .
2. Take the screen as a viewfinder and move the terminal until you get the images you want to capture.
3. Tap the screen to focus. By default, the camera automatically senses the ambient light, and the flashlight will be opened if necessary.
4. Press the camera key  to take photos

### Shooting videos



This section describes how to use the camera function to shoot videos.

1. Tap All Applications and then tap Camera .
2. Tap Camera Shooting Options on the bottom right .
3. Tap  to choose videos

4. Tap  to start video shooting. To adjust the focus, you can knead two fingers on the screen; to capture images, you can tap on the screen for instant capturing during video shooting process.
5. To stop video shooting, tap  .

## Changing video settings

In order to obtain the best results when shooting videos, users can change the camera settings beforehand.

1. Tap All Applications and then tap Camera .
2. Tap .
3. Tap settings on the top right corner or slide to the right to view Video Options.
4. Tap any other positions of the screen to enable or disable Camera Options.

## Chapter V - Using Telecommunication Function

You can use the phone function of the terminal (Only for EDA51-1 WWAN version) to make and receive calls, and to transmit data via wireless network as well.

### Telecommunication Function

The phone function of the terminal is realized with a speaker and a microphone. The phone function also supports a Bluetooth headset or hands-free device. The EDA51 will use loudspeaker mode without connecting Bluetooth headsets or other external audio devices. The phone function is enabled by default.

This terminal supports the following network types:

- GSM&EDGE: Band2/Band3/ Band5/Band8;
- WCDMA: Band1/Band2/Band4/Band5/Band8/ Band9/ Band19;
- CDMA: BC0/BC1/BC6
- FDD-LTE: Band1/ Band2/ Band3/ Band4/ Band5/ Band7/ Band8/ Band9/Band19/Band20/ Band26;
- TDD-LTE: Band38/ Band39/ Band40/ Band41;

When users enable the phone function and activate the service through wireless carriers, they can customize the phone features and network settings in the Mobile Network interface in Settings.

**Note: EDA51-1 WWAN version supports automatic system time setting with network messages and timezone messages (NITZ).**

### Activating calls

Calls can be activated by inserting Nano SIM card in the terminal. Nano SIM card can be purchased from the network service provider.



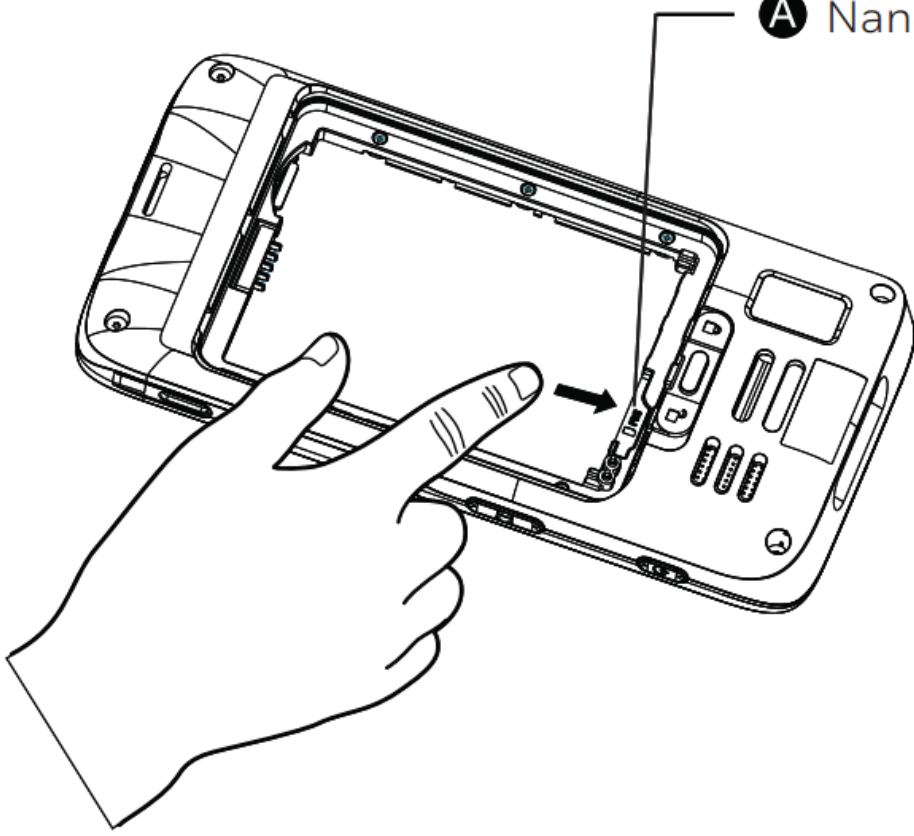

1. Turn off the terminal.
2. Press down the battery cover safety button to move the lock to the unlock position at right;
3. Unlock the battery cover using its lock handle;
4. Remove the battery (remove it from its bottom end before pulling it out);
5. Open the cover of SIM card slot.
6. Insert the SIM card from the SIM card slot until hearing a click.
7. Press down the cover of SIM card.
8. Insert the battery (Insert the connector side first, then press the battery down to establish connection between the battery and the phone).
9. Press down the battery cover (Insert the connector side first, then press down the battery cover).
10. Move the battery cover safety lock to the lock position at left.
11. Turn on the terminal.

**A** Nano SIM Card







## Making a call

- After the phone is successfully activated, you can make calls.
- Click  on the main screen or display screen.
- If the screen shows numbers list and not telephone keyboard, lightly press  to return to the keyboard;
- Enter the numbers and lightly press  below to make the call;
- To end the call, press .

## Answering a call

When a user receives an incoming call, the screen will be illuminated with the caller's number displayed. All calls are recorded in the call log. If you have missed calls, you will receive reminding notifications.

When there is an incoming call, tap the white phone icon and slide to any one of the following icons:

- Answer the call: 
- Hang up: 
- Send a message from the default list: 

## Switching applications during a call

Users can switch applications during a call. For example, users can use the Contacts application to find contact information during a call.

***Note: If the user only has WWAN connection, the applications requiring data connection may not be able to obtain network data during the call. Due to restrictions from network carriers, you can not receive multiple simultaneous calls and connections and voice calls will get priority. For more information, please contact your network carrier.***



During the call, tap the icon of other applications on the main interface or application interface to run the application, while the call icon shows in the status bar.

## Making an emergency call

If SIM card has been misplaced, or if the user does not have valid SIM card, the user can still make emergency calls. Under both circumstances the device will show no service access, but calls to emergency numbers (e.g. 112, 110, 911, 118, 119, 120, 122 or 999) will still be connected.

## Configuring call settings

Users can customize phone settings, including display options, Sounds and vibration, Quick responses, Speed dial Settings, Calls, Call blocking, Accessibility.

1. Tap .
2. Tap  Settings to show Call Settings menu.
3. Change the settings based on your needs.

## Chapter VI - Configuring Terminal

This Chapter deals with configuration of EDA51-X. The user can also learn how to configure network communication and wireless security.

### Terminal configurations

Users can configure many parameters for the terminal, such as barcode symbologies to be decoded or network settings. These parameters set by the user decide how the terminal works.

Users can configure the terminal in Application Settings.

### Setting launch applications

Set the applications using the application menu.

Tap **Setting**.

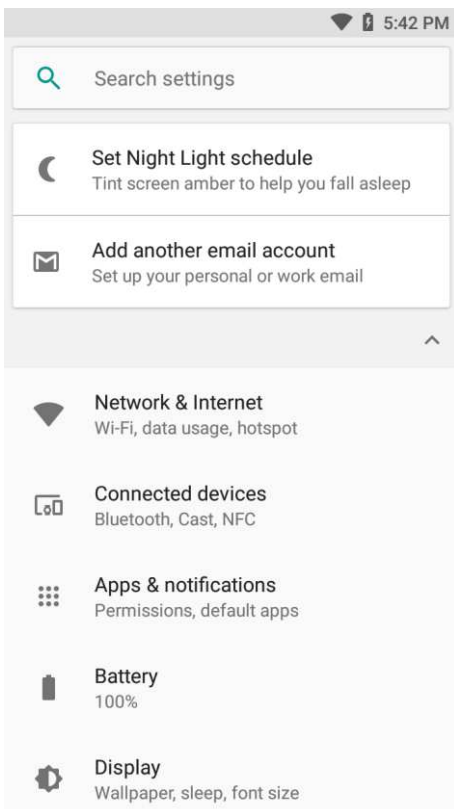

### Structure of the Application Settings

The section describes the structure of Application Settings to make it easier for users to quickly locate respective specifications.

**Suggestions**

Automatically recommend quick access through intelligent pre-judgment of user’s needs.

**Networks& Internet**

Settings	Introductions
Wi-Fi	To enable or disable Wi-Fi radios. When Wi-Fi is enabled, available Wi-Fi networks can be viewed by tapping this bar.
Mobile network (only supported by EDA51-1 WWAN)	(This menu will be displayed after inserting SIM card) Enable or disable mobile data. When it is enabled, tap the bar to view available mobile network).
Bluetooth	To enable or disable Bluetooth radios. When Bluetooth connection is enabled, Bluetooth-enabled devices within the range can be viewed by tapping this bar.
Data usage	Displays the current usage of flow rate, including Wi-Fi and Cellular data. (Cellular data will be displayed after sim card is inserted).
Hotspot & tethering	Use hotspot and tethering to provide Internet to other devices through your mobile data connection. Apps can also create a hotspot to share content with nearby devices. (only supported by EDA51-1 WWAN).
Mobile Plan	Plans provided by network carriers.
VPN	Set a password for accessing the virtual private network.
Airplane mode	To enable or disable Airplane mode.

**Connected devices**

Control and indicate the devices which connected to EDA51 terminal.

Bluetooth	Enable or Disable Bluetooth function, and setup Bluetooth connection with other devices.
Cast	Cast the device screen onto a specific device
NFC	enabling NFC allows NFC tag information to be read when the terminal touches NFC tag.
Android Beam	when NFC is enabled, this function allows users to send the application contents from the terminal directly to another NFC-supported device when the two get closer.
Printing	Add printer to EDA51 terminal, provide printing service.
USB	Display the USB port connection status.

## Devices and Google settings

Below list regular function and google settings.

<b>Settings</b>	<b>Introductions</b>
Apps& Notifications	Set whether the app allows notifications to be sent, and Shows applications downloaded and on the run.
Battery	Shows battery usage data and the current battery status.
Display	Set screen brightness, wallpaper, screen timeout, font size and screen rotation.
Sound	Set sound for calls and notifications, including the tone and volume.
Storage	Shows the remaining memory space.
Security& Location	Set screen lock and administrator privileges, including application installation and data storage security. And To enable or disable location information (Google).
Users& Accounts	Add toggle user, and Set up an e-mail account.
Accessibility	Set auxiliary function level, for example: large font and text-to-speech output.
Google	Related services of Google

## Honeywell Setting

Settings	Introductions
Scan Settings	Provide the scan settings, detail to refer <b>ChaterIII</b>
Key Remap	Redefines buttons. For more information please refer to <b>Chapter II, Key Remap</b> section
Key WakeUp	Enable or Disable left/right scan key, volume up/down keys to wake up the terminal.
Smart sensors	Integrated sensor allows better power management
Provisioning Mode	Enable or disable allowing unrestricted installation of applications, certifications, configuration files and licenses.
Battery Optimizer	Optimize the terminal to power saving mode, under this mode some of the terminal performance would be degraded and some of the applications can't be used.
Battery LED	Configuring battery LED lighting modes.
Battery Monitor	Display the battery using stage, health and internal temperature.
HXLogger	Activates Android Logcat and Linux Kernel log services to facilitate identification of problems during the device's operation
Honeywell Bug Reporter	Enable or disable auto Send bug reports to Honeywell server
Web Applications	Configure the Web application.

## System

Settings	Introductions
Languages & input	Configure the terminal language and input keypad type
Gestures	Define physical keys operation to have special function
Date & Time	Configure all time and date settings.
Backup	Back up user data to google driver
System update	Check and update system update option
Reset options	Reset the terminal to default setting and remove user data
About phone	Shows information about the terminal system.

## Network communication

Users can connect the terminal to wireless and wired networks. Users can get the terminal connected via the following ways:

- Mobile network
- 802.11 radios
- Bluetooth
- USB

### Connect to Mobile network

Mobile network only supported on EDA51 WWAN version, like EDA51-1. Before using mobile network, need insert activated local carrier's Nano-SIM card.

1. Enter **Settings>Mobile network>Mobile data**
2. Tap **mobile data** to on(Default status is on)
3. Using the terminal transfer data through local carrier's network.

### Connecting to Wi-Fi networks

When communicating through wireless networks, EDA51-X transfer data through 802.11 radios. Before connecting to a Wi-Fi network, users need to know the Security Protocol of the network and the certificates it required. Usually, 802.11 radio is disabled by default.

1. Enter **Settings > WLAN**.
2. When the WLAN switch turns blue, tapping the WLAN bar will display the detected network list.
3. To search the network outside of the list, slide to the end of the list and tap **Add network** and enter the network name.
4. Tap on a network name to view its details.

If the network is secure, a form will pop up asking you to fill in the necessary information (for example: certificate name, password or other credentials). To connect to a secure network, enter the required information, and then tap **Connect**.

- To leave the network that has been connected, tap **Forget**. For example, users can choose to forget a network that they won't use again.
- To close the network information screen, tap **Cancel**.

## Configuring Wi-Fi network proxy servers

If users need to connect to network resources through a proxy server, they need to configure a proxy server for each Wi-Fi network added. By default, none of the Wi-Fi networks added by users has done proxy server settings.

1. Enter Application Settings screen, tap Wi-Fi to show available Wi-Fi networks.
2. Long press the network name, then tap **Connect the Network**, then a network setting list will pop up.
3. Choose Show Advanced Options at the bottom of the network setting list.
4. If the network does not have proxy server settings, tap **None** on the proxy server setting list, and then tap **Manual Settings**.
5. Enter the network proxy server settings.
6. Tap **Save**.

*Note: Proxy server settings only apply to the Wi-Fi networks that users modified. Users should set proxy servers for each network that requires the using of proxy server.*

## Disable Wi-Fi notifications

Wi-Fi is enabled by default. Users will receive notifications in the Status Bar when the terminal finds wireless networks. Users can disable these notifications.

1. Enter Application Settings screen.
2. Tap Wi-Fi bar.
3. Tap the Settings icon on the top right.
4. Uncheck the Network notification to disable Wi-Fi Notifications.



## Connecting to a virtual private network

The terminal supports connection to virtual private networks (VPNs). This section describes how to add and connect to VPNs. To configure a VPN, users must consult your network administrator. Users can view and change VPN settings in the Application Settings.

*Note: Before accessing VPN, users need to set a lock screen password.*

### Add VPN

Before connecting to a VPN, users must first add the relevant information of the VPN.

1. Enter Application Settings screen.
2. Tap **Network & internet**.
3. Tap **VPN**.
4. Tap VPN +.
5. Input the VPN information.
6. Tap Save, and VPN name will be displayed in the list.

### Connect to VPN

1. Enter Application Settings screen.
2. Tap **Network & internet**.
3. Tap VPN.
4. Tap the VPN name in the list, and enter the certificate information based on the tips.
5. Tap **Connect**. The terminal gets connected to the VPN, and the status icons and notification will be displayed.

To disconnect from the VPN, tap the notification.

### Edit VPN information

1. Enter Application Settings screen.
2. Tap **Network & internet**.
3. Tap VPN.
4. Long press the name of the VPN to be edited and select Editing Networks from the list.
5. Edit VPN information based on your needs.
6. Tap **Save** after editing.

## Wireless Security

The terminal provides the following security solutions for users' wireless network.

- WPA2™
- WPA
- 802.1x
- LEAP
- WEP

Before setting up security program, you must first enable the radio and set the date and SSID on the terminal. To use 802.1x program, users must download a root certificate to the terminal. To use Transport Layer Security protocol (TLS) together with 802.1x , users also need to download a user certificate first.

View and configure all of the wireless security settings in the Application Settings screen.

## Bluetooth communication

EDA51-X supports Bluetooth communication, allowing users to get connected with other Bluetooth-enabled devices.

Bluetooth radio can be restored to its current state by system resetting. If users have reset the system data, they must re-establish the paired devices. Bluetooth status is displayed on the System Icon bar.

Pairing with a Bluetooth-enabled device

To connect to a Bluetooth-enabled device, users should enable Bluetooth radio first and then choose the device from the detected device list.

1. Enter Application **Settings** screen.
2. Tap **Connected devices**.
3. Tap **Bluetooth**. If Bluetooth switch is off, slide it on.
4. Tap **pair new device**. It will display available Bluetooth-enabled device list.
5. Select the device to pair with. After Pairing Dialog Box is displayed, enter the device PIN code, and tap **OK**. When the device and the terminal s have been successfully paired, the device name will appear in the list of paired devices at the top.
6. To disconnect with the paired device, tap the Quick Setting icon beside the device name, and then tap **Cancel Pairing**

*Note: Before searching for and connecting to other Bluetooth-enabled devices, users must enable the Bluetooth radio. By default, Bluetooth radio is disabled.*

## USB Communication

By communication via USB, users can transfer data to other devices or receive data from other devices with the following accessories.

EDA51-X terminal can connect the USB device via micro USB2.0 port.

## Near Field Communication (NFC)

NFC technology provides short-range wireless data transmission between EDA51-X with NFC tags or other NFC-enabled devices near its back.

NFC-enabled EDA51-X models support the following operations:

NFC tag read / write mode: The terminal reads digital information from the NFC tag or writes information into NFC tag.

*Note: When in sleep mode (suspend mode) and lock-screen state, NFC radio will be temporarily disabled.*

## Chapter VII - Management and Maintenance

This Chapter deals with software upgrade, resetting terminal and maintenance of EDA51-X.

### Upgrading system software

The other system softwares of EDA51-X can be upgraded by downloading ".zip" files from the Technical Support Website. Website: <https://hsmftp.honeywell.com/>

#### Upgrading AutoInstall application

1. Copy the upgrade file "EDA51\_OTA\_XXXXX\_Update.zip " to the following EDA51-X's system folder:
  - o File Explorer\External Memory Card\Honeywell\Autoinstall
  - o IPSM\Honeywell\Autoinstall
2. Tap **All Applications > AutoInstall Settings**.
3. Choose **Packages update**, and EDA51-X will restart and install the upgrade file.

#### Manually upgrading Recovery Menu

1. Copy the file " EDA51\_OTA\_XXXXX\_Update.zip " to the root directory of the T card.
2. Turn off the terminal, press and hold the "**Power button**" + "**Volume+**" key for about 15s, then the phone will enter **Recovery Menu**.
3. Press "**Volume-**", and select "**Apply update from SD card**". Press "**Power button**", select the zip file just copied, then press and hold the "**Power button**".
4. After the upgrading is completed, it will automatically move to **Reboot System Now Menu**. Please press the "**Power button**" to restart the terminal.

## Restarting the Terminal

If the terminal or an application is locked or doesn't respond when pressing the power button, you need to restart the terminal.

When restarting, the terminal will use the current configuration saved in the flash memory. Try the following ways to restart the terminal:

- **Restarting the system:** Restarts the terminal's operating system
- **Restarting hardware:** If there is no response after pressing the **power button**, hold it down for 13 seconds to force restart of the device
- **Restore default settings:** Clears all data in the terminal including all applications, data and files except built-in files or data in the movable storage device

### Restarting the system

When an application is not responding, you may need to restart the terminal to resolve the issue.

1. Save the file and close open applications.
2. Press and hold "**Power button**" until the following interface displayed:

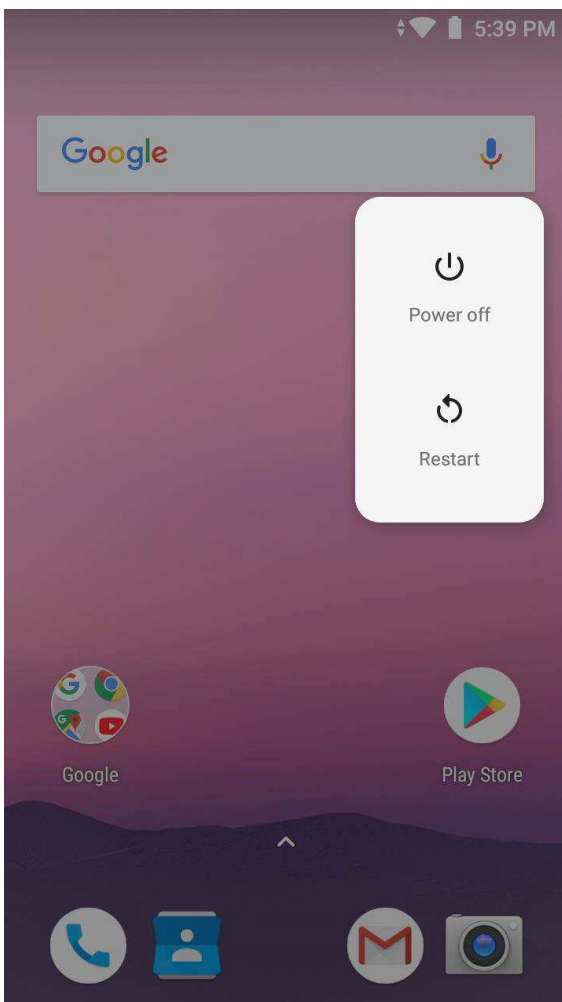

3. Tap **Restart** to restart EDA51-X.

## Restore factory settings

If the terminal appears to be locked, try a cold boot. If resetting is invalid, try to restore factory settings, restart the terminal to make it work again and do troubleshooting later.

1. Tap **Settings**.
2. Tap **system**.
3. Tap **Reset options**.
4. Tap **Erase all data (Factory Reset)**.
5. Tap **Reset Phone**.
6. EDA51-X will restart and automatically clear user data.

**Warning:** *This action will clear all data in the terminal, including all applications and data, but excluding data stored in flash memory or external storage device.*

## Cleaning the terminal

In order to ensure the terminal in good working condition, you need to clean the scan window, camera and touch screen. Based on the environmental conditions where the terminal is being used, clean these parts at regular intervals. Use a clean, soft cloth which dampened with the following solvents for the cleaning, and quickly wipe it with another piece of clean, soft cloth.

- Acetic acid (10% soluble in water)
- Ethanol (10% soluble in water)
- Neutral soap solution



**Warnings:** this product includes non-user-serviceable parts inside. Disassembling the product may prevent warranty and cause internal damages to the product.



**Note:** We advise you not to open the battery cover or remove the battery, so as to avoid the liquid flowing into the internal part of the terminal from the SIM card and SD card interface.

1. Press the **power button** to enter standby mode.
2. Dip a clean cloth in detergent, then wrung out excessive water.
3. Wipe the scanning window, camera and flash area, avoiding touching these areas with hard objects or abrasive materials.
4. Dry the cleaned area.
5. Make sure the terminal is fully dry before using it again.

## Chapter VIII - Specifications

### Mechanical and environmental specifications

This Chapter provides the mechanical and environment specifications of EDA51-X

#### Product dimensions

<b>Physical dimension</b>	Length	157mm
	Width	78.2 mm
	Thickness	16.9 mm
	Weight (with battery)	272 g (with battery)
<b>Tumble and Drop</b>	Tumble	300 tumbles within 0.5m
	Drop	Multiple drops form 1.2 m to concrete at room temperature
<b>Battery and Charging</b>	Battery	Rechargeable Li-ion battery
	Charging power	5 V, 1.2 A
<b>Environment</b>	Operating temperature	-10 °C ~ 50 °C (14 °F ~ 122 °F)
	Storage temperature	-20 °C ~ 70 °C (-4 °F ~ 158 °F)
	Relative humidity (Operation)	10% to 90%, non-condensing
	Environmental sealing	IP64

## Display specifications

5.0-inch color LCD/1280x720 pixel HD/full-perspective/capacitive touch screen

## Language Support

Language Supports and not limited to WW English, French, German, Italian, Spanish, Simplified Chinese, Traditional Chinese.

## Symbolgies Support

The following symbologies are supported:

### 1D codes:

- Codabar
- Code 3 of 9
- Code 11
- Code 32
- Code 39
- Code 128
- EAN-8
- EAN-13
- GS1-128
- Korea Post
- IATA 2 of 5
- Industrial 2 of 5
- Interleaved 2 of 5
- ISBN
- ISBT 128
- Matrix 2 of 5
- MSI Plessey
- EAN.RCC (RSS-14)
- RSS Limited
- RSS Expanded
- Telepen
- Trioptic Code
- UPC-A
- UPC-E

### 2D codes:

- Aztec Code
- Codablock A
- Codablock F
- DataMatrix
- GridMatrix
- HanXin
- Maxicode

- Micro PDF 417
- MicroQr
- PDF 417
- QR Code
- TLC39
- OCR-A
- OCR-B

**Postal codes:**

- Australian Postcode
- Canadian Postcode
- KIX (Dutch) Postcode
- Japanese Postcode
- UK Postcode
- Planet Code
- Postnet
- UsIntelligent
- Info mail
- UPU(ID-tag)



## Scan Depth of Field (DOF)

DOF performance of the product was measured under the following conditions:

- DOF is the distance from the top of scan engine to the barcode
- 23 °C (73 °F), 0 ~ 10K lux
- Clear, high quality barcodes

**Note: If the barcode is not aligned well with the scan engine, reading time and depth of field (DOF) will be affected and the device performance will be decreased.**

	Near distance (in/mm)	Far distance (in/mm)	Delta (in/mm)
5mil code39/128	3.4 (86)	13.5 (135)	10.1 (49)
13mil UPC-A	1.8 (46)	11.4 (290)	9.6 (244)
6.7mil PDF417	2.4 (61)	6.3 (159)	3.9 (98)
10mil Data Matrix	2.8 (70)	6.9 (176)	4.1 (106)



**BSR idware GmbH**

Jakob-Haringer-Str.3

A-5020 Salzburg

<https://www.bsr.at>

[sales@bsr.at](mailto:sales@bsr.at)