

NAUTIZ X2

QUICK START GUIDE



BSR idware GmbH

Jakob-Haringer-Str.3

A-5020 Salzburg

<https://www.bsr.at>

sales@bsr.at

handheld

① WHAT'S IN THE BOX

The pictures shown below may differ from the actual products. To purchase additional or optional products, contact our customer center.

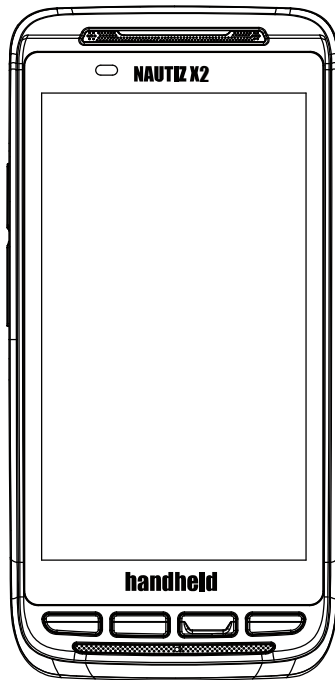

Nautiz X2 Main body

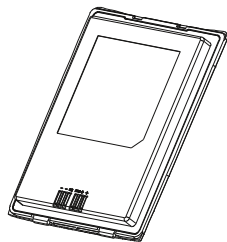

Standard battery

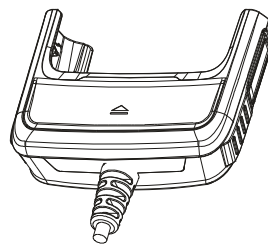

Charging dock



USB cable

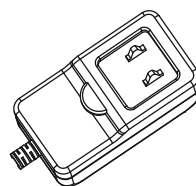

Adaptor

② YOUR NAUTIZ X2

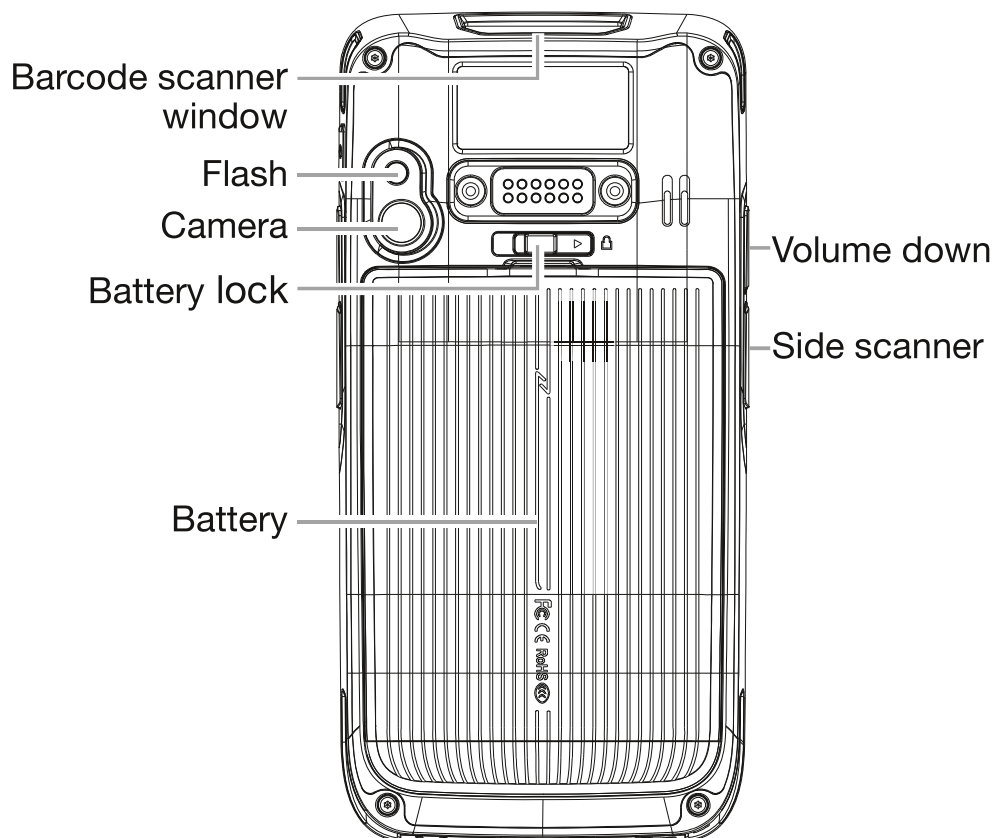
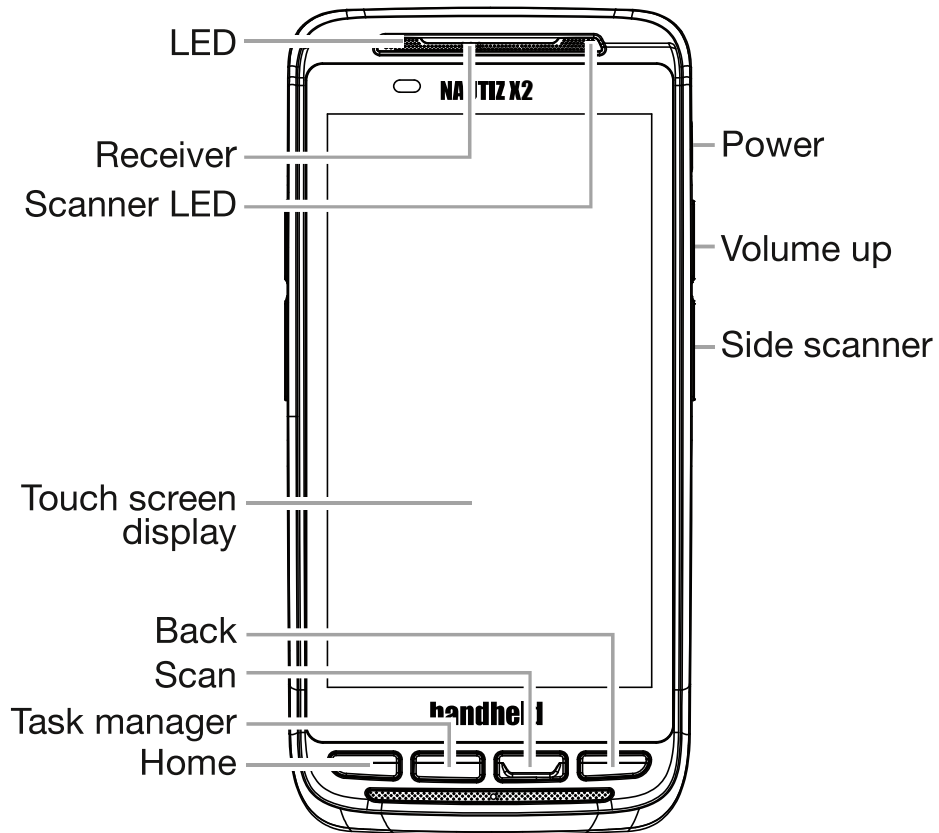

③ INSERT/REMOVE BATTERY

To insert the battery

1. Insert the battery.

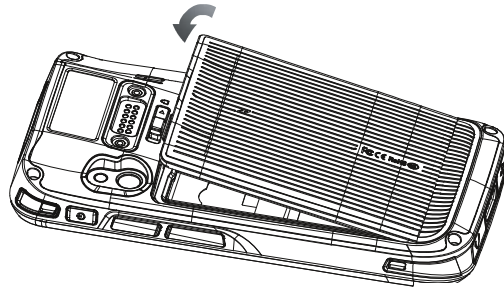

2. Slide the battery lock to the right.

Battery door lock

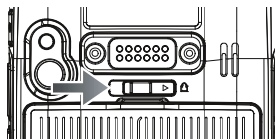

To remove the battery

1. Slide the battery lock to the left.

Battery door unlock

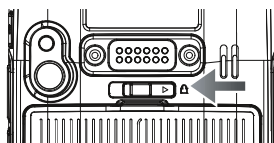

2. Remove the battery.

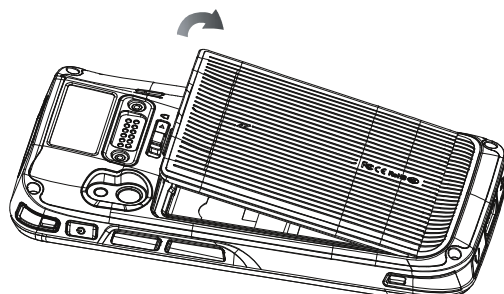

④ INSERTING/EXTRACTING SIM/MICRO SD CARD

This is how you insert and remove the SIM/micro SD.

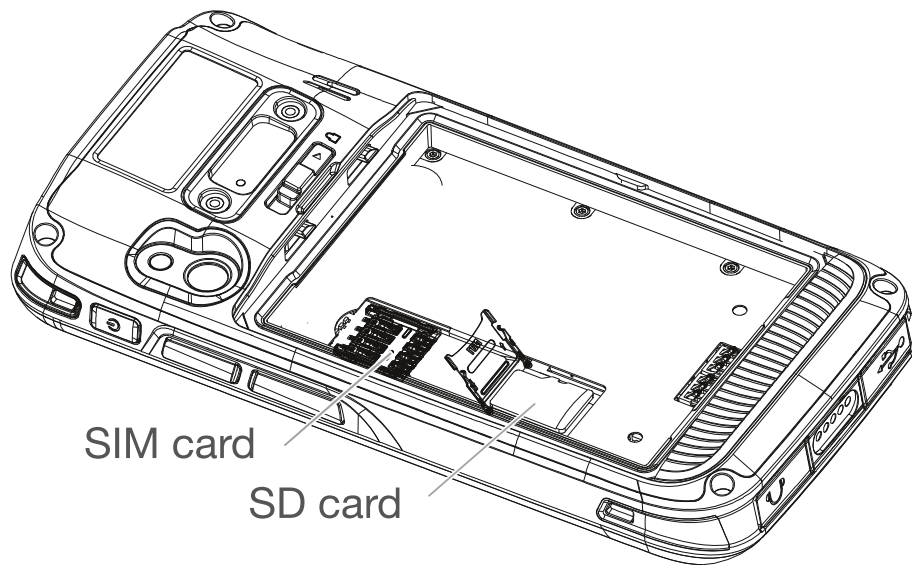

⑤ USING SCANNER

Scanner function is by default turned OFF.

How to enable barcode scanning feature:
Settings > Scan Setting > Enable

Press the [Front Scan] or [Side Scan] button to start scanning.

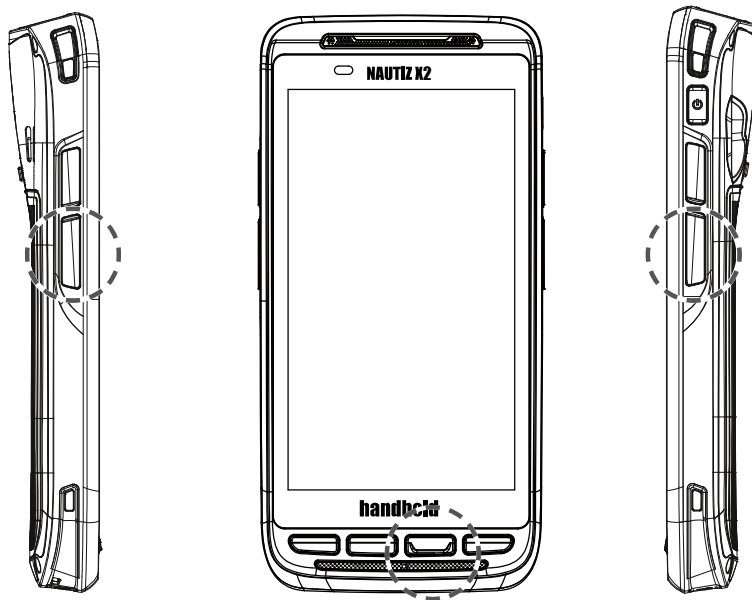

Scanning Barcode

To scan a barcode, keep a distance of about 10 cm between the barcode and the barcode scanner window and scan the barcode at the correct angle.

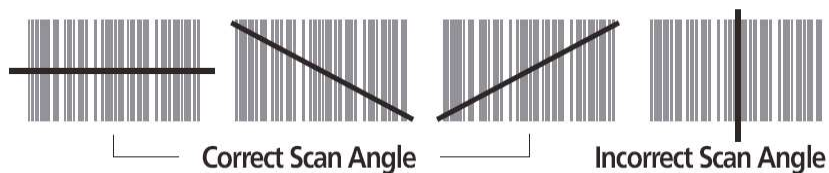

⑥ POWERING ON/OFF

Press the [Power] button to turn the Nautiz X2 unit on/off.

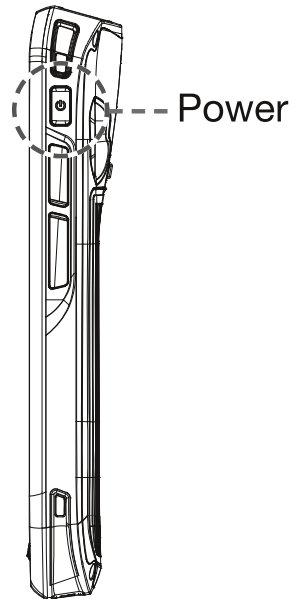

⑦ BATTERY CHARGING

Use supplied power adapter or charging dock to charge the Nautiz X2.

Please go to www.handheldgroup.com/knowledgebase to download more information.

Google, Google Play and other marks are trademarks of Google LLC.
Handheld Rugged Mobile Computer.



BSR idware GmbH

Jakob-Haringer-Str.3

A-5020 Salzburg

<https://www.bsr.at>

sales@bsr.at

handheld

www.handheldgroup.com

Version 1.3