

REFERENCE GUIDE

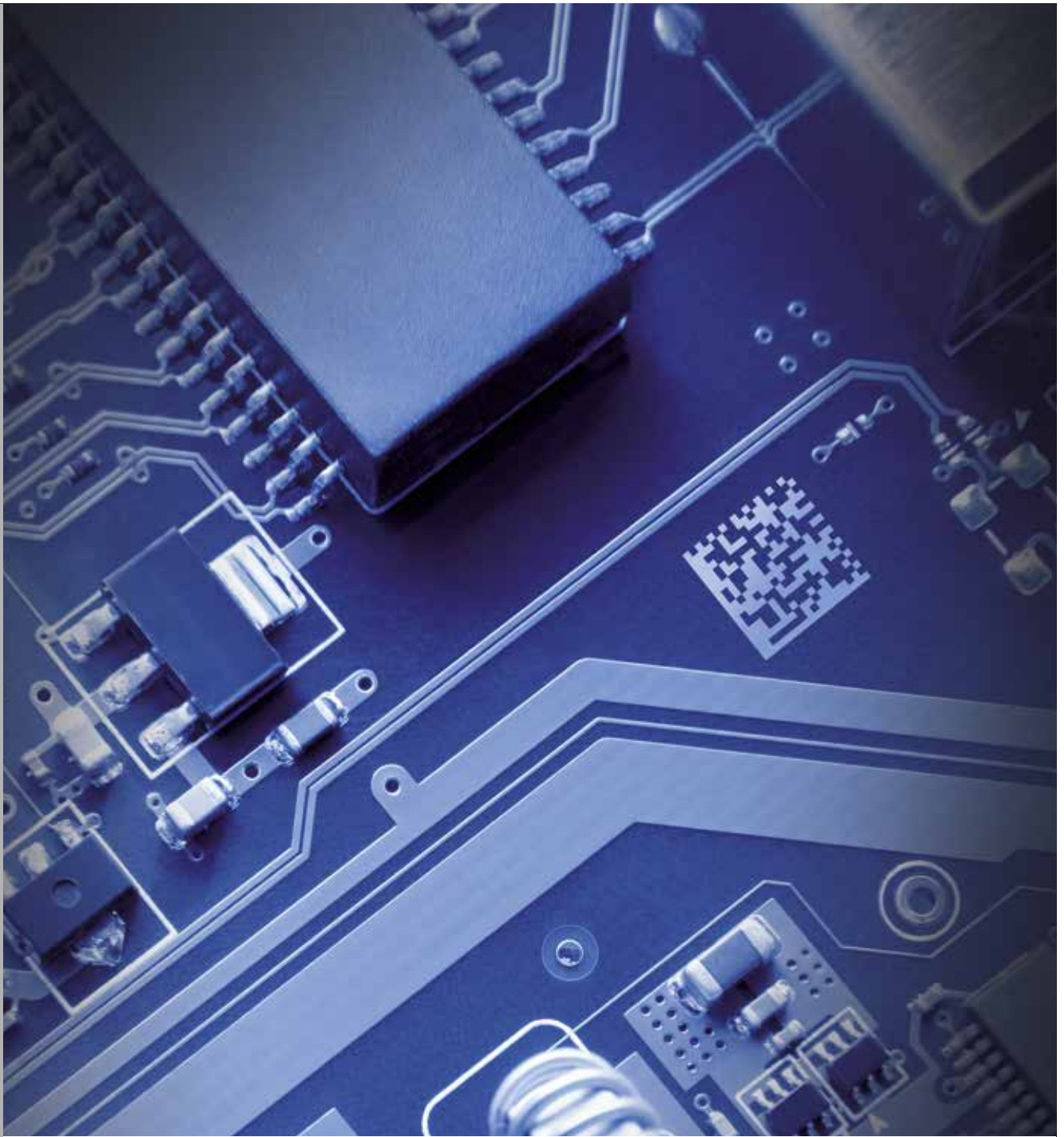

> Identification

> Manufacturing



DATALOGIC
THE VISION IS YOURS



BSR idware GmbH
Jakob-Haringer-Str.3
A-5020 Salzburg
Web: www.bsr.at



DATALOGIC: SOLUTIONS FOR INDUSTRIAL AUTOMATION

Datalogic Industrial Automation is an industry-leader in products and solutions for material handling, traceability, inspection and detection applications.

With the acquisitions of Accu-Sort and PPT Vision in 2012, the company offers a comprehensive portfolio of products, technologies and solutions delivered by a team of skilled professionals dedicated to providing superior service to customers.

Datalogic is the partner of choice for organizations in the Industrial Automation market.

Manufacturing

- AUTOMOTIVE
- ELECTRONICS
- FOOD & BEVERAGE
- GENERAL MANUFACTURING
- HEALTHCARE - PHARMACEUTICAL

Transportation & Logistics

- AIRPORTS
- COURIER, EXPRESS PARCEL (CEP)
- POSTAL
- RETAIL DISTRIBUTION

Product portfolio

Datalogic Industrial Automation has the most comprehensive offering of products and solutions for traceability, inspection and detection applications in factory automation and logistics processes: industrial LASER scanners, cameras and vision systems, sensors, machine safety devices and LASER markers.

Identification

Even the most demanding and efficient automation of identification processes can leverage Datalogic Industrial Automation's leadership in the market. We manufacture the world's most comprehensive family of fixed-mount line and omnidirectional scanners.

We also offer the latest CCD vision technology with the world's largest installed base of CCD systems for bar code reading and dimensioning.

All of our AUTO-ID products and solutions leverage the broadest decoding library that has been developed through the years. Datalogic's comprehensive AUTO-ID portfolio is used in a wide range of applications and machines which are behind many of the everyday processes that keeps the global economy running.

Sensors & Safety

Datalogic Industrial Automation offers a best-in-class, comprehensive product portfolio of photoelectric and proximity sensors, rotary encoders, temperature controllers and measurement devices, as well as type 2 and type 4 safety light curtains.

These product lines provide solutions for applications involving color, contrast and luminescence, label detection, dimensional and distance measurement, in addition to machine safeguarding and access control in dangerous areas.

Machine Vision

The Datalogic Industrial Automation machine vision product line encompasses both hardware and software while covering a wide range of performance and price point requirements. The vision portfolio of products and solutions ranges from standalone compact smart cameras to the highest performance embedded processors.

Laser Marking

Laser Marking sources and systems provide value driven marking solutions for automotive, metal tools, medical, electronics and packaging. Datalogic Industrial Automation offers an extensive range of state-of-the-art technology, excellent performance and high reliability marking equipment.





DATALOGIC: SOLUTIONS FOR INDUSTRIAL AUTOMATION	6
MANUFACTURING TECHNOLOGIES	8
Imager Technology	10
Laser Scanners	12
Linear Cameras	14
MANUFACTURING APPLICATIONS	16
Electronics	18
Automotive	20
Tires	22
Food & Beverage	24
Pharmaceutical & Cosmetics	26
Warehousing	28
IDENTIFICATION PRODUCT PORTFOLIO	30
2D Imagers	32
Laser Scanners	38
Industrial Handheld Devices	44
Linear Imagers	46
Dimensioner	48
Connectivity	50



DATALOGIC: SOLUTIONS FOR INDUSTRIAL AUTOMATION

Datalogic's global leadership position in identification is built on its 40 years of experience and was solidified by the 2012 acquisition of Accu-Sort Systems. With continuous product innovation, Datalogic's reputation continues to grow as an expert in the industrial stationary scanners segment, with a market share over 30%. Datalogic is the only company in the world providing solutions utilizing all three identification technologies (Laser Scanners, 2D Imagers, & Linear Imagers) and a unique, comprehensive product portfolio backed by the expertise of its own, global network of experienced engineers and technicians.

> INNOVATION

Through continuous development and refinement, boosted by the 2012 acquisition of Accu-Sort Systems, Datalogic offers the most complete hardware and software solutions available on the market today.

> EXPERIENCE

With over 40 years of experience in Identification and the largest install base of bar code reading 2D Imagers, Datalogic is the global leader in identification solutions. By leveraging its deep industry knowledge with its comprehensive in-house resources, Datalogic provides customers with turn-key solutions that perfectly match their needs.

> SERVICE

Datalogic goes a step beyond providing the best identification solutions on the market and engages customers in a true partnership, providing superior support throughout all stages of the project lifecycle. Datalogic offers localized phone support, a team of on-site technical support, and extended warranties on all products. Datalogic's support is designed to ensure operations run as efficiently as possible and exceed the highest industry standards and customers expectations.

TECHNOLOGIES

LASER

Bar Code Laser Scanners

The tried-&-true solution in the Identification field, Datalogic has decades of experience utilizing the intrinsic benefits of Laser Scanners to create products and solutions that reliably outperform while providing an easy to use, cost-effective option.

1974

M10 is the first stationary device manufactured in Europe for Industrial Automation

1984

The first automatic bar code reading station in an airport (Milan, Italy)

1984

Introduced the first bar code reconstruction algorithm on laser scanners

1985

First omnidirectional laser scanner

1985

First bar code reader with linear CCD technology for Industrial Automation

1989

First use of the laser diode in bar code readers

1997

Patent issued for Astra Technology, auto focus system based on multi-laser technology

1997

First linear CCD camera for high speed logistics applications

1997

First dimensioning solution

1997

First parcel system with OCR capabilities

1999

Introduced the world's first 6 sided camera tunnel

As the only identification solutions provider with experience in all three technologies, Datalogic utilizes its comprehensive portfolio of Laser Scanners, 2-D Imagers, & Linear Imagers to create superior Factory Automation solutions for all real-world applications.

Electronics

Food & Beverage

Automotive

Pharmaceuticals

Tires

Warehousing

In the increasingly demanding world of Factory Automation, Datalogic offers innovative and reliable solutions in traceability, inspection, detection, and verification. With the largest, bar code reading, 2D Imager install base in the world; Datalogic leads the industry in Identification.

2D IMAGER

LINEAR IMAGER

LARGE PRODUCTS PORTFOLIO AND SOLUTIONS

2D Imagers

With state-of-the-art technology, Datalogic 2D Imagers are easy to use while providing excellent performance and advanced identification/verification features. Beyond decoding 2D bar codes, Imagers are the ideal solution for Direct Part Marking (DPM) and capturing critical tracking information.

Linear Imagers

For ultra-high resolution applications & high speed image elaboration, Linear Imagers offer unsurpassed performance. Capable of handling large depths-of-field and large fields-of-view, while providing OCR and Video Coding functionality.

The only company in the industry offering all three of the identification technologies, Datalogic provides an unparalleled range of product options within each technology. Laser Scanners & 2D Imagers are available from the ultra-compact and cost-effective to high-end performance systems. With 40 years of experience plus a comprehensive array of technology and product options, Datalogic provides the best solutions based on the exact needs of the customer.

2000

Introduced Datalogic's first 2D Imager. Datalogic becomes the only supplier with all three ID technologies

2001

First CCD linear camera with integrated illumination for high speed logistics applications

2006

First 2D Imager Array (STS-400) for tire track and trace applications

2007

Patent issued and product delivered for first Industrial Imager with green spot technology

2011

Datalogic acquires Accu-Sort Systems, Inc.

2012

Matrix 450 2D Imager deployed in logistics applications

2013

Matrix 300™ Best-In-Class Family of Bar Code Readers

2014

Datalogic revolutionizes T&L markets with DM3610 Dimensioner

2015

Ready. Set. Read. DL.CODE™ and Matrix N™ Line: a new generation for 2D bar code reading

2016

Datalogic Announces the New AV7000 Linear Camera and presents the Matrix 120, the smallest ultra compact industrial 2D imager



MANUFACTURING TECHNOLOGIES



IMAGER

EXCELLENT PERFORMANCE

Embedded Low Angle & Powerful Illumination

- Direct part marked codes
- Highly reflective surfaces
- Textured materials
- Low quality codes



Liquid Lens Technology

- Extremely fast focus change
- Ultra reliable: no moving parts



Aggressive Decoding

- Up to 250 codes in a single frame
- Decodes all common 1D, 2D, Postal & Stacked Codes
- Best solution for low aspect ratio codes
- Omni directional reading, without any special mounting orientation

High Resolution Cameras

- Up to 5.0 MPixels camera
- Reads on extremely small codes
- Large coverage area
- Extreme precision



Multiple Imaging Technologies

- **CMOS:** best on high contrast (highly reflective surfaces), does not allow pixel to pixel leakage at saturation
- **CCD:** higher resolution

EASE OF SETUP

Blue Diamond

- Aiming and focusing system
- Projected on scan area
- Intuitive, very easy setup
- Reduces overall setup time
- Find scanning area without errors

X-PRESS™



- Intuitive Human Machine Interface designed to improve the ease of setup and use
- Immediate feedback on code reading
- Ease of installation
- Ease of maintenance
- Reduce overall setup time
- Diagnostics at a glance

Smart Fast Bracket

- Flexible installation, easy replacement

Embedded Ethernet Connection

- Fast setup and integration - remote monitoring

Power Over Ethernet

- No need for additional connectivity accessories

Embedded PROFINET

- No need for external boxes or fieldbus modules

Cluster setup through Master

- Configure slave readers with a single connection to the master

FLEXIBLE SOLUTIONS

Modular Design

- Compact and rotating connectors for tight spaces
- Higher reading flexibility through the combination of sensors, lenses and lightings
- Interchangeable illuminators and lenses reduces stock requirements

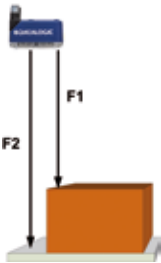

Electronic Variable Focus

- Multiple focus setup for different reading distances
- Optical setup can be performed or optimized AFTER the reader is installed inside the machinery
- No need to manually access lens
- Adjustable reading distances

C-Mount Adjustable Lenses

- Adaptable to many applications
- Optimal image quality
- Low cost: reduces stock requirements, easier replacement

ID-NET™ is a dedicated high-speed channel for scanner interconnection.

- Allows for multiple Imagers to read:
 - On different sides of the same objects (i.e. 360° of bottle)
- On different production steps of same conveyor
- On independent conveyors

EASE OF USE



Green Spot

Immediate feedback: patented **Green Spot** projected on surface to indicate good read.

Long Term Reliability

No moving parts: no motor, no laser

Run-Time Self Tuning

- Automatic gain adjustments
- Best image acquisition
- Lower operational cost



REMOTE MONITORING

The WebSentinel™ PLUS remote monitoring software collects diagnostics, performance and images from any reader in a plant.

- Remote surveillance and control
- Standard Web interface
- Storage of all functional data & captured images

INDUSTRIAL STRENGTH

The rugged construction of Datalogic 2D Imagers stands up to the most severe environments, and makes them ideal products for industrial applications. Designed for maximum robustness, enclosures have a wide operating temperature range, complete dust and water protection, and meet an IP67 Rating.

- Circular sealed connectors
- Operation temperature 0 to 50°C
- IP-67 protection
- Rugged housings
- Rugged construction



HAND HELD 2D IMAGER TECHNOLOGY

2D Imager technology integrated into the most versatile hand held Imagers with powerful decoding capabilities utilizing:

- Motionix™ motion-sensing technology
- 'Soft white light' illumination
- Framing aimer for instant sighting
- High resolution, wide viewing angle with large depth of field



DL.CODE™



The new DL.CODE software offers a usable interface that is:

- Customer ease of use
- Fast setup, automatic
- Intuitive since graphical
- Large format images

DL.CODE software incorporates a high level of innovation, designed to exceed customer's needs.

LASER SCANNERS

EXCELLENT PERFORMANCE & RELIABILITY

EASE OF SETUP

Smart Focus Adjustment

- Easy focus selection
- Run-time feedback on display
- Self-tuning based on selected focus
- Flexibility to match different application needs
- Improved reading performance based on focus

X-PRESS™ Interface

- No PC needed to setup scanner
- Reduce overall setup time
- No technical skills required
- Easy check of reading area
- Fast tuning of scanner positioning
- Auto Learn – self detect barcode
- Auto Setup – self optimize reading performance
- Test Mode – check scanner performance

Embedded Multilanguage Display

Immediate feedback on bar code reading performance



INDUSTRIAL STRENGTH



Environmentally Robust

- Complete ambient and external light immunity
- 0-50°C operating temperature
- Industrial rating class
- Rugged construction

Low Temperature Version

- Operating down to -35°C
- Integrated heating system
- Heater cold start
- Internal temperature control

ASTRA - EXTENDS DEPTH OF FIELD AND READING PERFORMANCE



- 2 Lasers covering a wide area
- Guaranteed performance over the entire Depth of Field
- No auto-focusing mechanisms, no moving parts
- Excellent reaction time to irregular shapes
- Easy laser alignment

DIGITECH™ DIGITAL POTENTIOMETER



- Software controlled digitizer
- Performance repetitiveness
- Better performance, on low-contrast and fast-moving codes
- Easy parameter portability
- Reading optimization on cartons and damaged barcodes

Aggressive, improved reading performance by means of standard software parameters for optimization.

EASE OF USE

Genius™

User-friendly, Windows-based Configuration Software Tool



- Standardized software configuration tool
- Windows platform
- Multi-language
- Pre-configured recipes for easy setup (i.e. 'black bar code on cardboard')
- Parameter configuration, calibrations and setup are completely performed by Genius™

e-Genius™

web browser configuration tool



e-Genius is compatible with any type of device (PC or TABLE or Mobile device) and it is compatible with any type of Operating System (Microsoft, Apple, Linus, Android)

ENHANCED CONNECTIVITY

Fieldbus Connectivity through a Complete Range of Modular Boxes

Profibus



cc-Link



PROFINET



EtherNet/IP



ACR4™ TECHNOLOGY



Code Reconstruction Algorithm (decoding), reducing decoding errors increases the overall reading performance

Reduces 'no read' and sorting errors with excellent performance on: stacked codes, damaged codes, bar and space distortion, noisy surfaces, reading damaged and poor barcodes in a non-linear fashion.

- Software controlled digitizer
- Better performance on low-contrast and fast-moving codes
- Reading optimization on cartons and damaged barcodes
- Performance repetitiveness
- Easy parameter portability

ID-NET™ INTERFACE FOR HIGH SPEED NETWORKING

Connectivity Solution for Every Application



- Master/Slave solution
- High speed bus for data collection
- Fast and efficient data exchange with customer host
- High performance (twice as fast, response time)
- Flexibility for future expansions
- Integration with most common Fieldbus systems
- Easy to configure, easy to maintain, easy to replace
- Cost savings: no multiplexer required

HAND HELD LASER SCANNING TECHNOLOGY

Laser scanning technology implemented into a diversified portfolio of hand held readers with unsurpassed decoding utilizing:

- 'Green-Spot' good-read visual feedback indicator
- PuzzleSolver™ decoding of poorly printed or damaged barcodes
- Large intrinsic depth-of-field with near to far range reading options
- Temperature tolerant optics for all environments



LINEAR CAMERAS

ULTRA-HIGH PERFORMANCE

Maximum Reading Distance & Depth of Field Coverage

- Scans up to 1m (39") high

Largest Field of View

- Up to 1,4m (55") (widest conveyor width)

Advanced Decoding Software

- Handles greatest code complexity
OCR and videocoding
- High resolution codes
- Fast compression of images reduces network stress

Tremendous Camera Speed

- 33,000 scans/s (33kHz)
- Highest throughput and conveyor speed to up to 5 m/s (940 fpm)
- Reduced gap between parcels

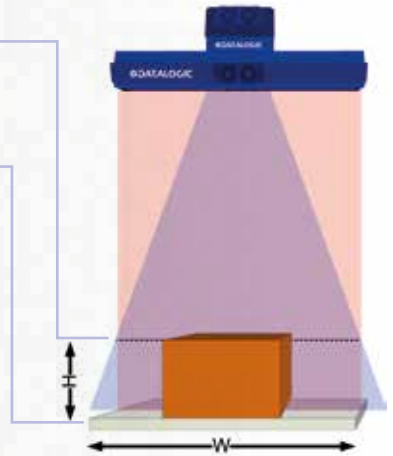

EASE OF USE

Real Time Operating System

Embedded architecture with ultimate flexibility

- Robust, reliable and secure
- Easy to maintain through web-browser/remote tool

STOP & GO - Higher Read Rates, Simpler Control

Easy and effective integration for all conveying systems wherever material flow

- Handles discontinuous conveyor speed
- Patented solution
- More productivity, easier integration
- Higher reading and sorting throughput

All major components are Field Replaceable Units (FRUs)

No need to replace an entire camera which would require realignment and recalibration

- Diagnostics pinpoint failure to FRU level
- FRUs designed to be changed in 5-10 min
- Simply replace the failed FRU and you're up and running!

Low Cost of Ownership

- Reliable and consistent
- Easy to use and control
- Energy efficient automation
- No rotating media eliminating hard drive failures
- e-GENIUS™ web-based user interface

LOW COST OF OWNERSHIP

- Reliability and consistency
- Robustness, reliability and security
- Easy to use and control
- Low maintenance cost
- Low downtime cost
- Low investment cost
- Less spare parts
- Energy efficient automation
- No rotating media means no hard drive failures

FULL INDUSTRIAL RELIABILITY

Ready for Every Harsh Environment

- Operating temperature: 0-50°C (32-122°F)
- IP65 protection
- Autofocus systems utilize simple mechanics and reliable thermal adaptation if need be
- Integrated decoder
- No hard disk
- Zero maintenance, no filters to be cleaned



REDUCED SYSTEM FOOTPRINT OVERALL DIMENSIONS

Pulsed Light Illumination

Alternating illumination control allows for crossing of camera beams to decrease system footprint.

- Patented technology
- Space saving design with half the overall installed dimensions
- Lower power consumption
- Energy efficiency 'green' automation
- Turns illumination off when no items in reading tunnel
- No sensor saturation and overloading at beam crossings

Flexible Layout

Possibility to install the system near curves and rises. No problems with obstacles near the conveyor area (pillars, pipes, electrical plants, etc...).

50% Smaller Overall Dimension
Compared to Competitor's
Configuration

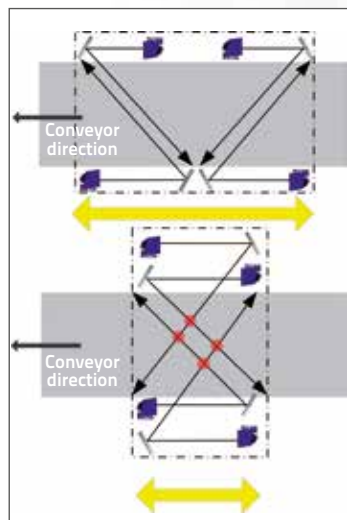

PERFORMANCE ORIENTED SYSTEM

Excellent reading performance providing robustness, reliability and security on a variety of bar codes



Damaged labels



Noisy backgrounds



Very low aspect ratios



Shiny codes or under plastic films

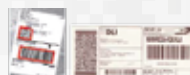

Bi-dimensional codes



Natural omnidirectional reading

REMOTE MONITORING

Remote data access and maintenance via web-browsers

- Ease of Use through complete remote control of the system
- Multiple reading systems surveillance and monitoring
- Extended diagnostics and statistics



MANUFACTURING APPLICATIONS



ELECTRONICS

PICK AND PLACE MACHINE SETUP

Identification of both the component cartridge and the appropriate insertion location.

BENEFITS

- Omnidirectional reading of 1D or 2D bar codes
- Reliable reading on direct part marked or print label bar codes
- Corded or cordless reading for cost effective solutions

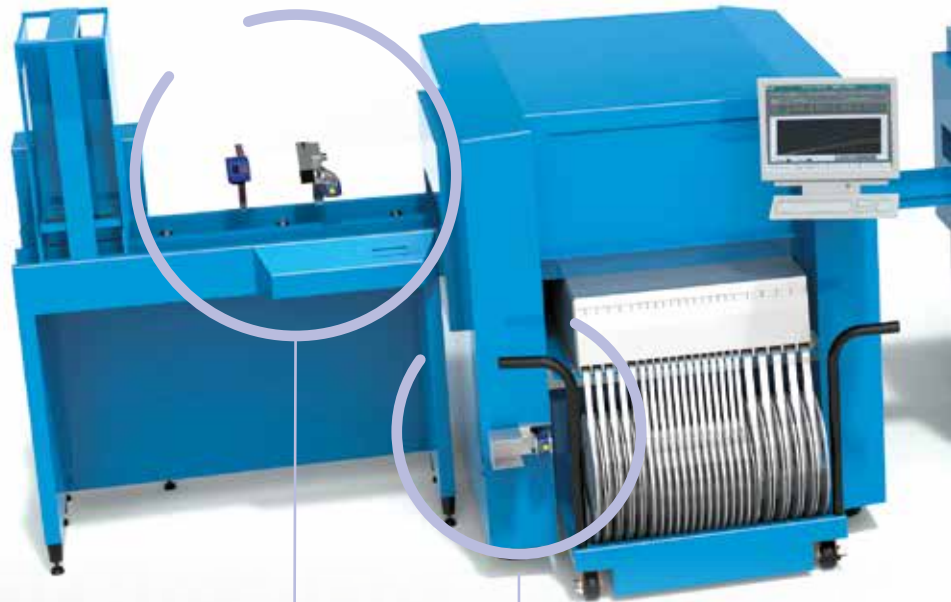

DPM READING AND CODE QUALITY VERIFICATION

Tracking of a PCB is made easy through Direct Part Marking (DPM). 2D code validation after a laser marking station assures the correct information and 2D code readability.

BENEFITS

- YAG laser marking protection for mark-and-read solutions
- High density code reading on very small codes
- Code quality analysis for statistical process trending

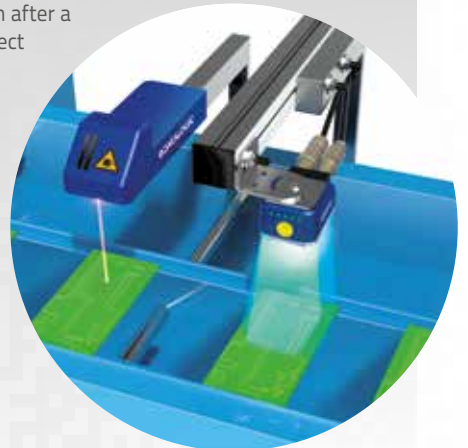

WORK IN PROGRESS CONTROL

Control of Work In Progress (WIP) with bar code reading and auto-ID stations along the entire production process.

BENEFITS

- ESD safe version compliant with electronic industry standards
- Comprehensive product portfolio for all customer needs
- High speed image acquisition
- Extended connectivity including all industrial fieldbus protocols

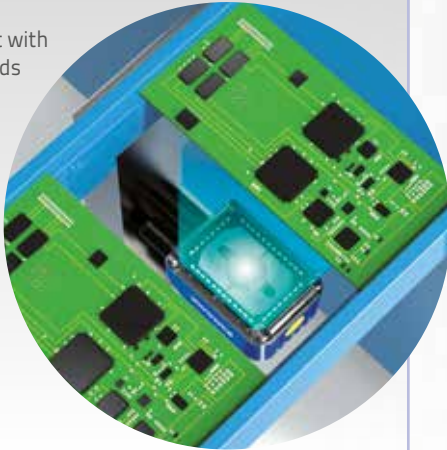

TEST TRACKING

Tracking of parts and subassemblies through testing stations, fulfills the quality standard requirements of creating a physical link between parts and its test report.

BENEFITS

- Cost effective solutions
- Easy to use and immediate HMI feedback, with 'green spot' verification
- Handheld reader and fixed position Imager applicable to any type of workstations

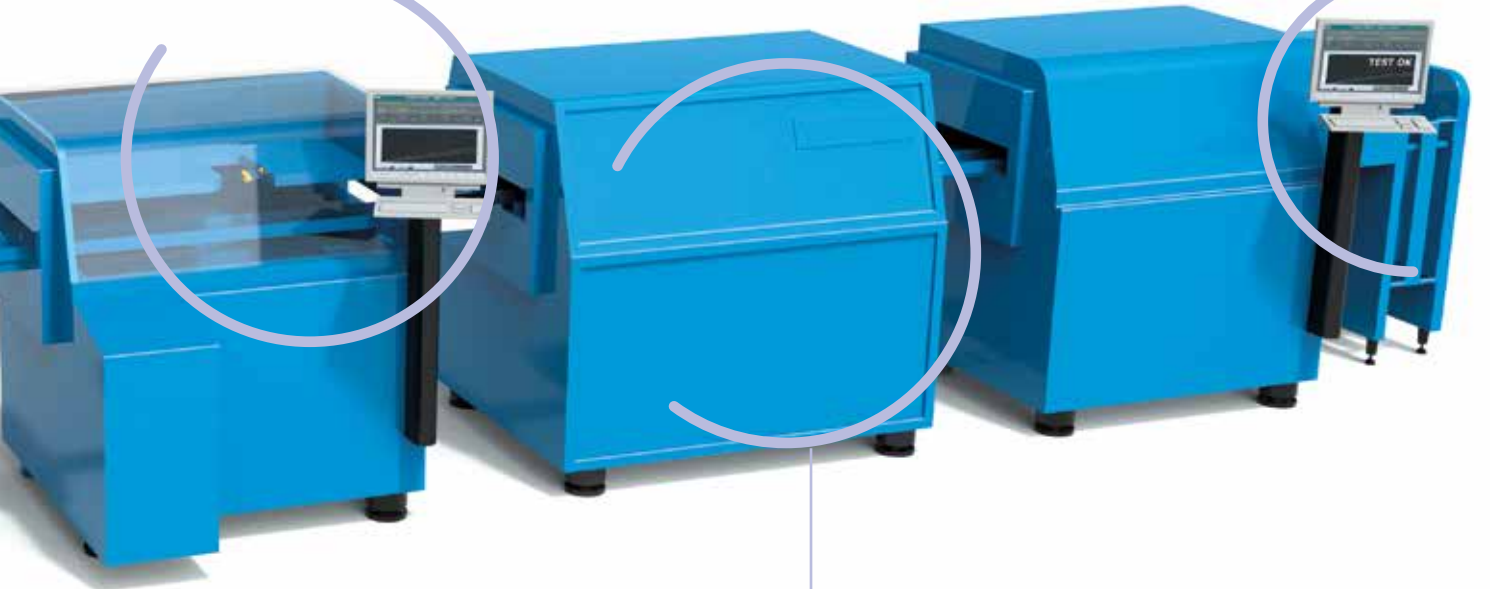

COMPONENTS TRACEABILITY

Identification of individual components is necessary in creating complete reports ('Identity Cards') for the many categories of equipment and electronic devices.

BENEFITS

- Excellent on high-resolution 2D codes
- Suitable for high-speed pick-&-place machine
- Excellent performance on DPM



PARTS TRACEABILITY AND CONTROL

Identifying / Tracking of parts and subassemblies at individual phases of the production process.

BENEFITS

- Compact 2D Imager offering wide-area scanning
- Extended depth of field and dynamic focus features
- Excellent performance-to-price ratio
- Image storage functionality for quality check

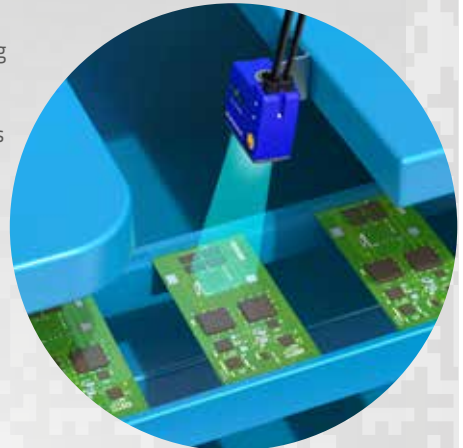

AUTOMOTIVE

DPM READING AND CODE QUALITY VERIFICATION

Tracking of components, which are not compatible with labels, is made easy through Direct Part Marking (DPM). Bar code validation after laser marking station assures the correct information and bar code readability.

BENEFITS

- Excellent Direct Part Marking application
- YAG laser marking protection, for mark-and-read solutions
- Effective on different material surfaces, utilizing innovative lighting and optical systems

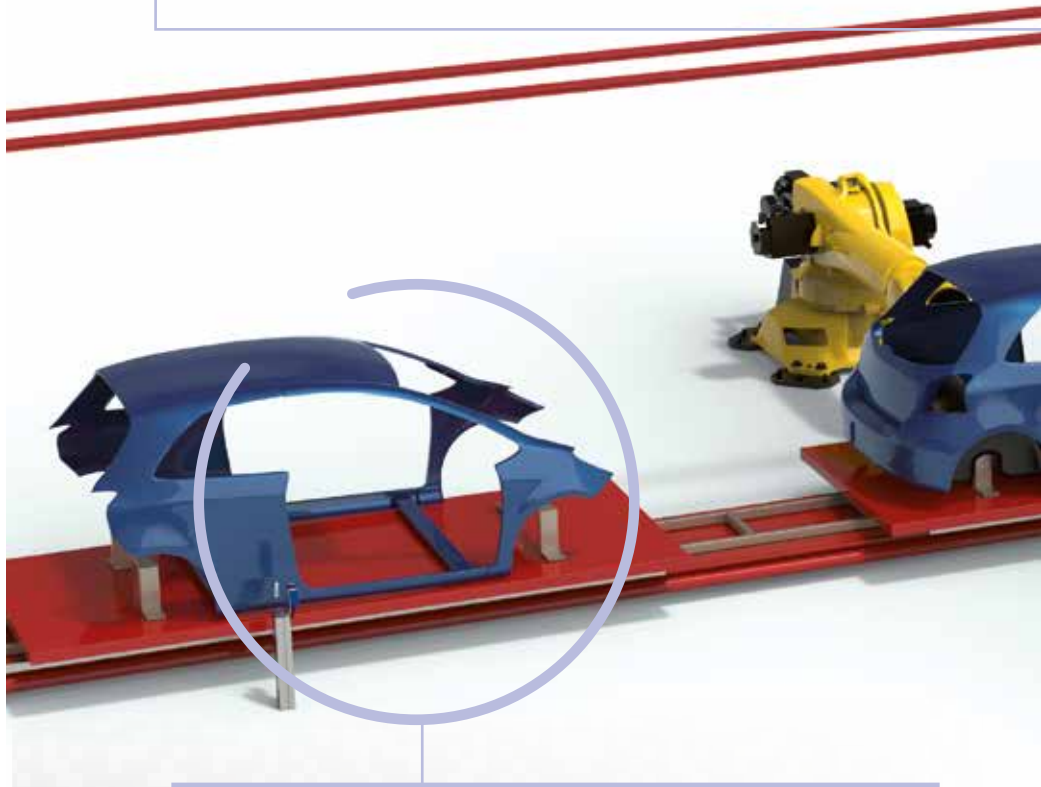

TRACEABILITY FOR MANUAL ASSEMBLY

Manually trace automotive components during vehicle assembly.

BENEFITS

- Fast and reliable performance on direct part marked codes
- Reads close or hard-to-reach bar codes (contact to 1 m / 3.3 ft)
- Coded and cordless models supporting any assembly process



WORK IN PROGRESS CONTROL

Control Work In Progress (WIP) with auto-ID and bar code reading stations along the entire production process.

BENEFITS

- Comprehensive product portfolio for all customer needs
- Extended connectivity including all industrial fieldbuses and embedded Ethernet
- Flexible installation with adaptive focusing

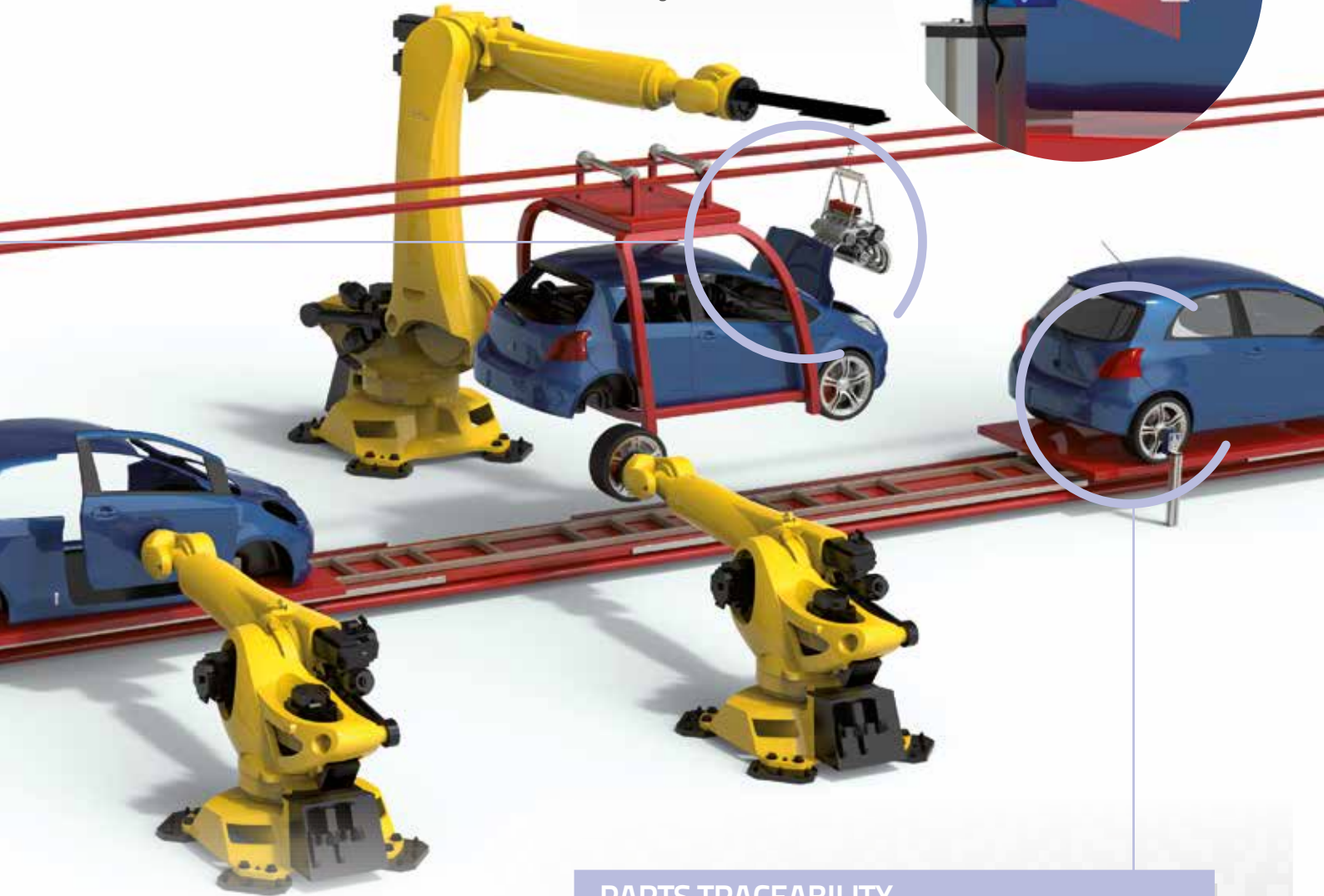

PARTS TRACEABILITY

Parts are identified with 1D or 2D codes having unique serial numbers to be saved in specific production databases.

BENEFITS

- Excellent performance on shiny, textured or brushed surfaces
- State of the art decoding algorithms and image elaboration
- Multi-pattern lighting system suitable for flexible production flow
- Production setup is made easy with dynamic focus range control



TIRES



FINAL INSPECTION

Tire identification for manual final finishing and inspection.

BENEFITS

- Reliable and fast first-pass reading of damaged bar codes
- Reduced total identification time with green spot good-read visual indicator
- Corded and cordless models to match inspection station design

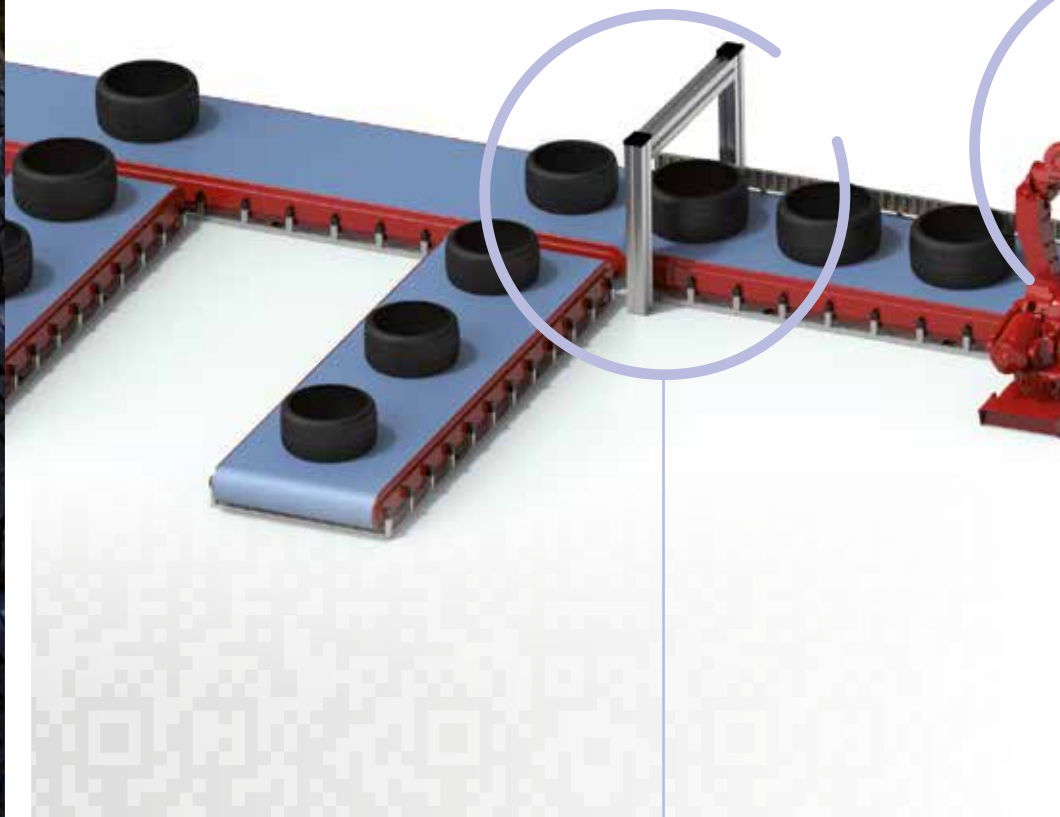

SORTING & SHIPPING

Tire bar codes are identified at shipment processing to correctly direct them to a distribution network or their final destination.

BENEFITS

- Outstanding performance on large conveyors and over a wide tire variety with STS400 (the industry standard for tire sorting)
- Best performance-to-price ratio with modular architecture and scalable solutions
- Industry's best read rate with high redundancy levels

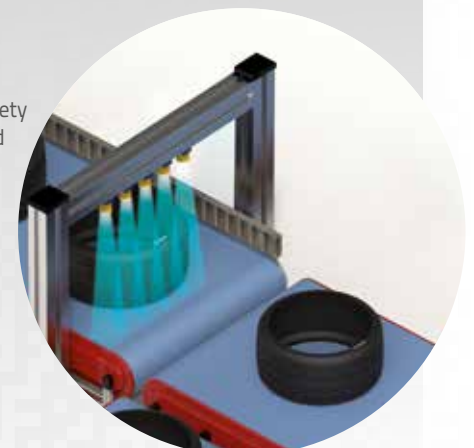

FINAL FINISHING & INSPECTION

Tires are identified and tracked as they progress through rough manufacturing and into final finishing and inspection stations.

BENEFITS

- Compact 2D imagers easily install inside of inspection machines
- Handles wide range of tire dimensions through advanced optic features
- Bar code image storage for quality control analysis



CURING PROCESS CONTROL

Each tire is identified before the vulcanizing process in order to match the specific tire to the correct curing press and process setup.

BENEFITS

- Widely recognized as the best performing solution by the tire industry
- Easy to use, standard solution (ST5400) with multi-head configuration
- Excellent reading performance on very low aspect ratio bar codes
- Redundant configuration and fault-tolerant architecture

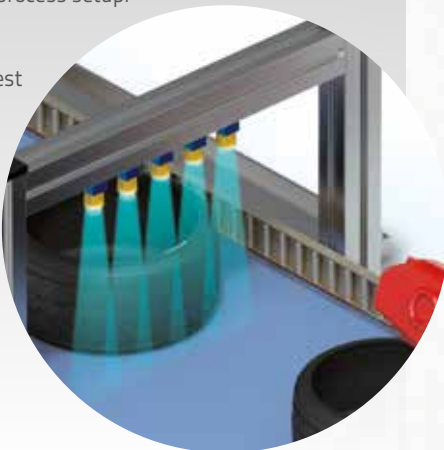

LABELING VERIFICATION

Bar code label is applied to 'Green Tire' for complete tracking of the tire through the manufacturing process

BENEFITS

- Image based technology without the need for autofocus
- Industrial design with IP rating suitable for tire manufacturing conditions
- Positive feedback visual indicator to line operator with Green Spot

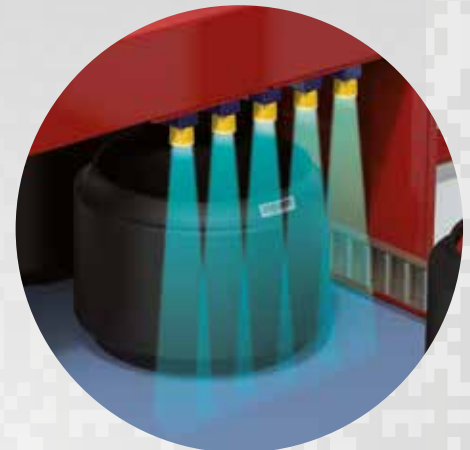

FOOD & BEVERAGE



MACHINE CONFIGURATION

Configure machine for operation using bar codes.

BENEFITS

- Snappy performance for quick and accurate setup
- Aiming and positive feedback systems for the operator
- Corded and cordless models for all machine designs

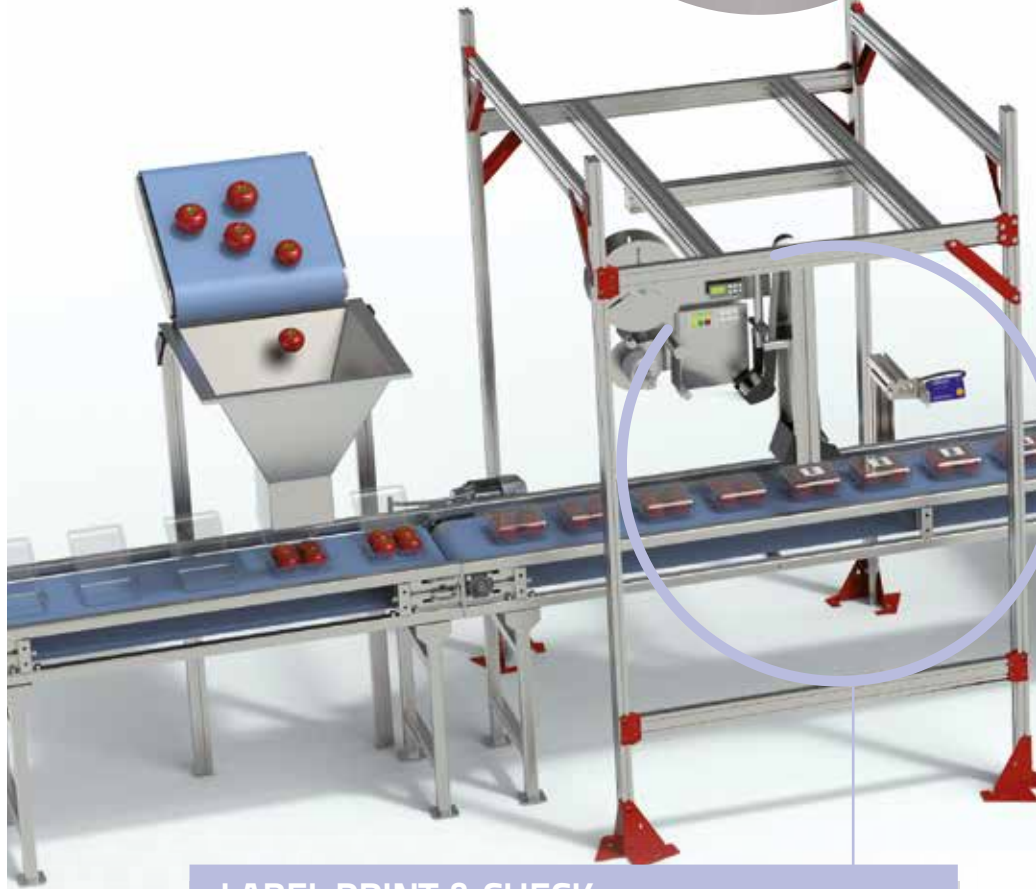

LABEL PRINT & CHECK

Bar codes are verified at printing and labeling stations, to check data consistency and maintain quality standards.

BENEFITS

- Ultra-compact readers perfectly install on small printing heads
- Lightweight readers ideal for moving robot arms
- Wide filed of view at short distances, minimizes overall size
- Imager based solution with bar code quality analysis for statistical process trending



SHIPPING PROCESS

Identifying and tracking products through shipping, as they transition from manufacturing into the supply-chain, increases throughput and productivity.

BENEFITS

- Read bar codes with large tilt angles or in omnidirectional conditions with ACR technology
- Wide reading area and large depth of field ideal for bar code reading over large conveyors and on products of varying size
- Excellent performance on high speed conveyors and small gaps between objects
- Accurate bar code reading with inkjet printing on cardboard boxes



PRODUCT TRACEABILITY

Raw materials are tracked, to guarantee food integrity, user safety, and efficient management of market recalls.

BENEFITS

- Fixed position readers for any type of installation
- Solutions designed for cold production environments (down to -35°C)
- Compliant for produce traceability initiative



END OF LINE PALLETIZING

Bar code labels are captured on pallets and large cardboard boxes as finished goods are palletized in multi-item containers.

BENEFITS

- Laser bar code readers provide extended field of view and large depth of field
- Excellent performance on low quality codes
- Complete range of connectivity options with Ethernet and fieldbus protocols

PHARMA & COSMETICS

MANUAL EXCEPTION HANDLING

Manual traceability of product exceptions or rejects.

BENEFITS

- Omnidirectional reading of 1D and 2D bar codes
- Aiming and positive feedback systems for the operator
- Exceptional performance on direct part marked codes

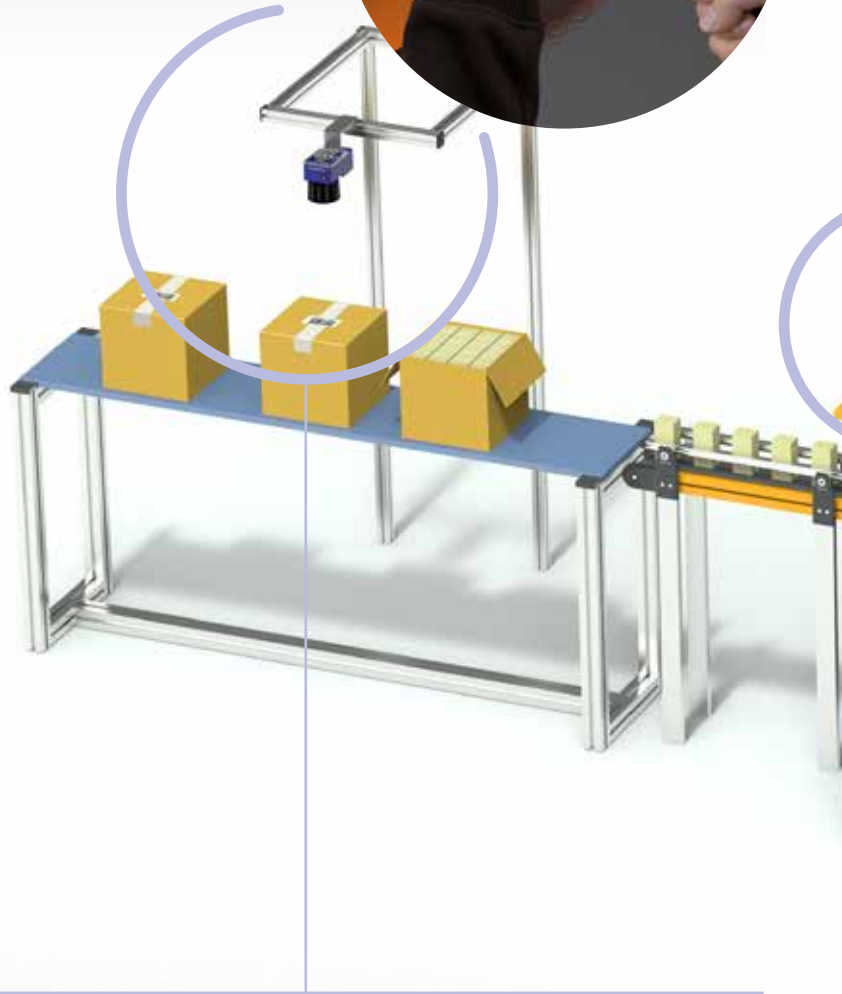

SECONDARY PACKAGE CONTROL

Identification technology validates and controls the distribution network in the supply chain, as primary packages are combined into secondary packaging boxes.

BENEFITS

- Extended field of view and depth of field offering flexible installation on packaging stations
- Accurate reading of low-quality codes from inkjet printing on cardboard boxes
- Complete range of connectivity options with Ethernet and fieldbus protocols



COMPLIANCE CONTROL

Identification and verification of product information, at different stages of the packaging process, guarantees data integrity and consistency in the pharmaceutical industry.

BENEFITS

- Excellent solutions for high-speed packaging machines
- Compact dimension for easy mechanical integration
- Large field of view at short distances provides solutions with minimum overall dimensions
- Easy to integrate with embedded Ethernet and PROFINET fieldbus

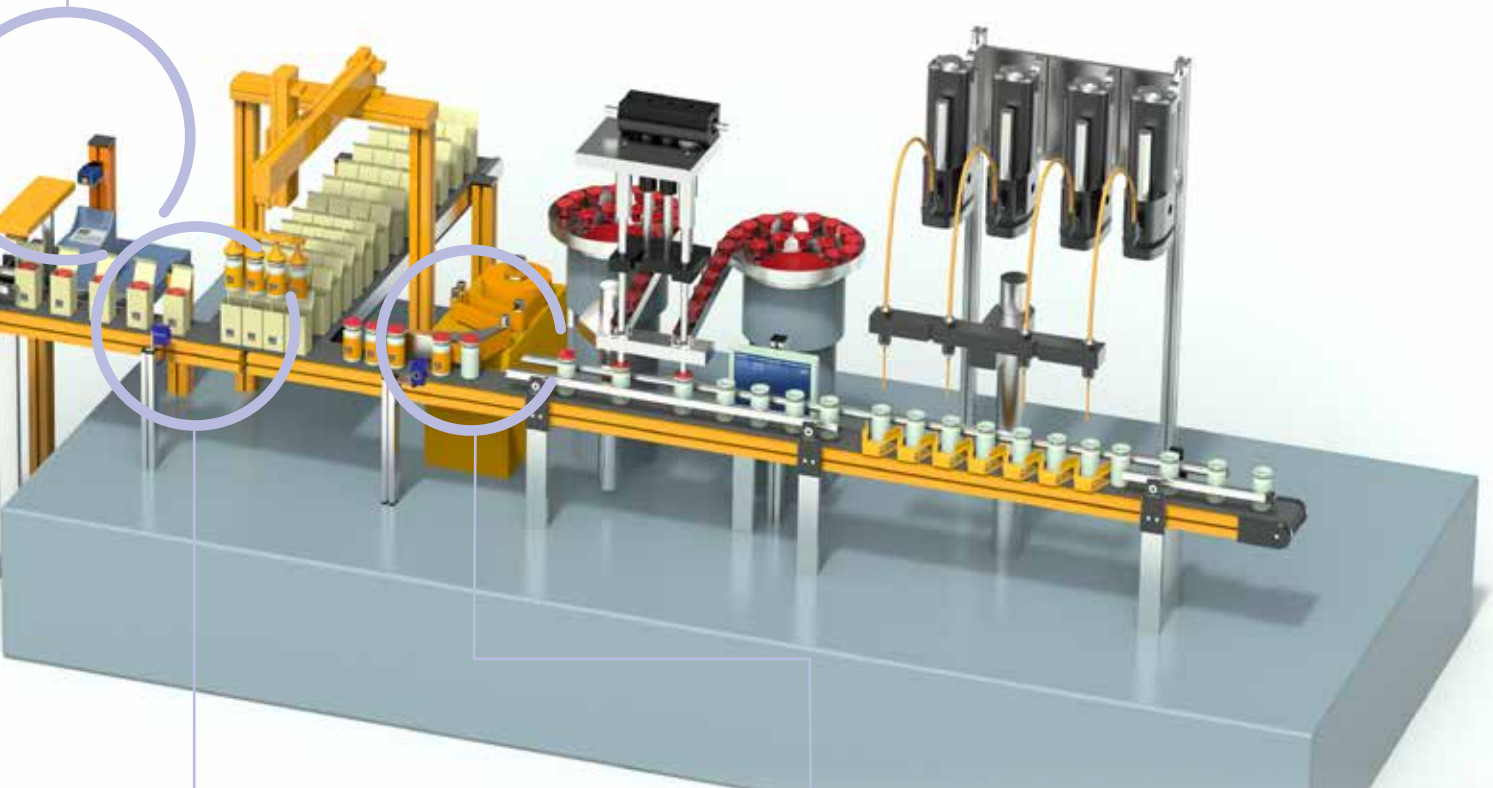

PRIMARY PACKAGE VERIFICATION

Accurate verification of primary package labeling is a necessity in pharmaceutical applications, and allows for efficient tracking, sorting, and inventory management.

BENEFITS

- Ultra-compact laser bar code reader works with small printing heads
- Imager based readers support 1D & 2D bar codes
- Lightweight readers ideal for moving robot arms
- Wide field of view at short distances, minimizes overall size

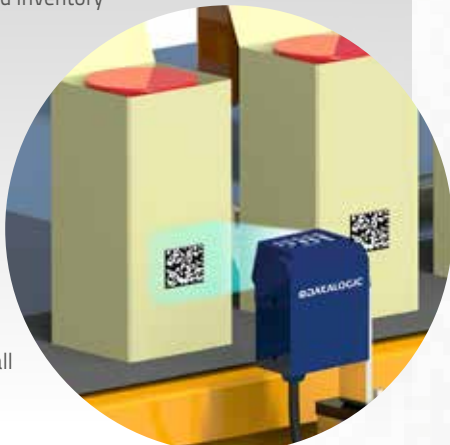

TRACK AND TRACE

Pharmaceutical industry requires high performance solutions for secure product tracking through all processes.

BENEFITS

- High performance laser and Imager, working at very high speed conditions
- Ultra-compact dimensions
- Imager based readers support 1D & 2D bar code symbologies



WAREHOUSING

TOTE TRAY IDENTIFICATION

Identification of bar code labels on tote-trays allows for accurate item conveyance, at different stages, inside of an automated warehouse.

BENEFITS

- Comprehensive portfolio of bar code readers for all application designs
- Excellent reading performance on low quality or damaged bar codes
- Complete range of connectivity options with Ethernet and fieldbus protocols

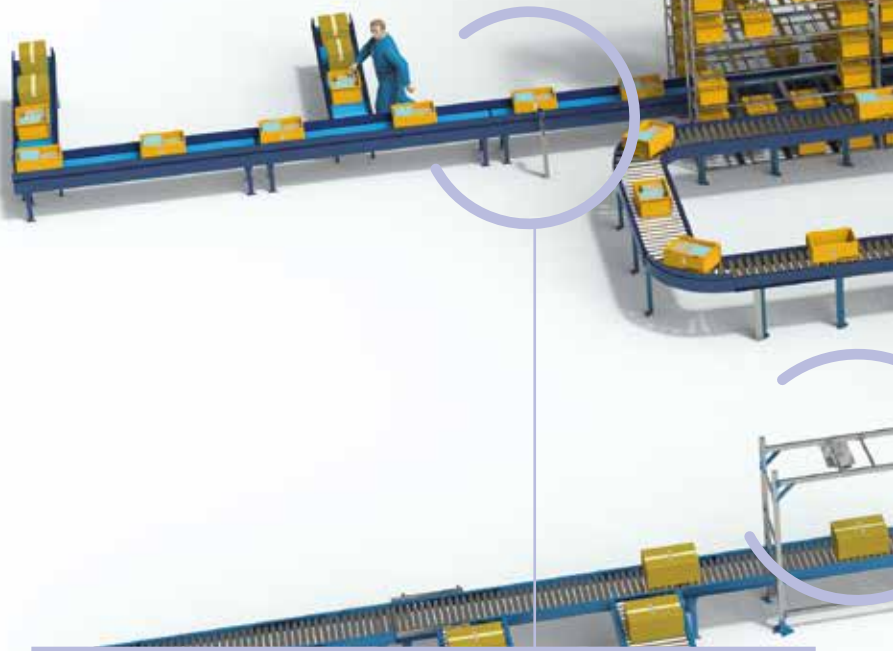

IDENTIFICATION FOR MANUAL INDUCTION STATIONS

Identification of bar code labels on totes or packages which are manually inducted into an automatic warehousing system.

BENEFITS

- Fast induction rates with omnidirectional reading
- Cordless reading providing station flexibility for operators
- Ergonomic features for highly intensive scanning



AUTOMATIC PICKING PROCESS CONTROL

Multiple verification steps, to match the lists of material with specific orders, ensures high accuracy for automatic picking and order processing.

BENEFITS

- Compact size bar code reader
- Flexible installation options with both straight or 90° exit window
- Flexible integration with Fieldbus (PROFIBUS/PROFINET/EtherNet/IP) communication



COLD STORAGE APPLICATION

Cold storage requires auto-ID solutions working in frozen environments to provide full traceability along the entire supply chain process.

BENEFITS

- Embedded heating system without external accessories
- Extended temperature range from -35°C to +50°C (-31°F to 122°F)
- The lowest energy consumption on the market



SORTING AND SHIPPING PROCESS

Flexible and robust identification solutions, laser or Imager, that work with any type of conveyor, supporting all aspects of the shipping process.

BENEFITS

- Omnidirectional reading stations meeting the needs of automatic sorting systems
- Integrated Scan & Dimension solutions for cost-effective parcel shipments
- Best performance-to-price ratio solutions utilizing laser or imager based solutions

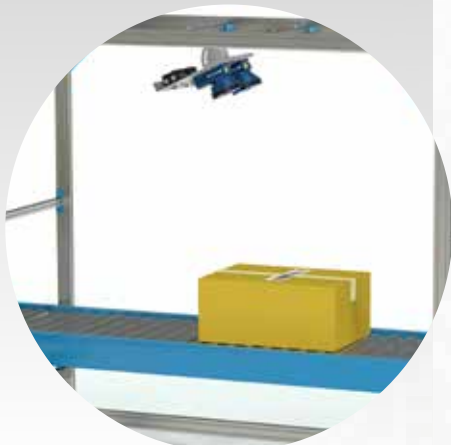

LABEL PRINT & APPLY VERIFICATION

Verification of printed and applied 1D / 2D bar codes allows for efficient identification of items inside an automated warehouse.

BENEFITS

- Ultra-compact laser bar code readers for small printing heads
- Lightweight readers
- Wide field of view at short distances, minimizes overall size
- Cost effective solution

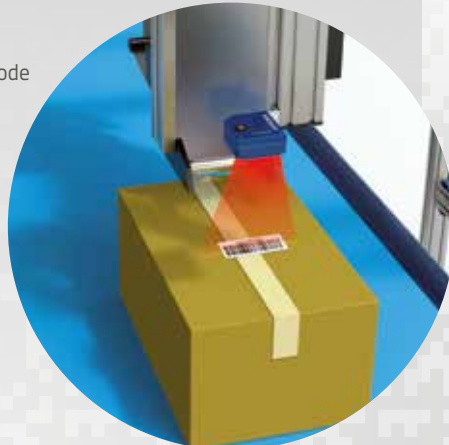



IDENTIFICATION PRODUCT PORTFOLIO



2D IMAGERS

TC1200



The TC1200 features state-of-the-art, CCD technology and sets a new standard in the auto-ID market for OEM and entry-level factory automation applications. Utilizing the innovative CCD technology, the TC1200 offers excellent reading performance, great decoding capability, and outstanding product reliability as well as ease of use with an HMI interface. The TC1200 is also available as a part of the Scan Engine package, a useful solution for applications where the CCD reader is applied inside a machine.

FEATURES & BENEFITS

- Linear CCD technology
- Excellent reading performance on bad label codes
- Very high resolution - codes up to 3 mils
- Serial and USB standard Interface
- Easy set up with Aladdin software tools and programming bar code label applications

APPLICATIONS

FACTORY AUTOMATION APPLICATIONS

Electronics: WIP Control, Test Tracking, Parts Traceability and Control

Automotive: WIP Control, Parts Traceability

Pharmaceutical: Primary Package Verification, Track and Trace

Warehousing: Tote Tray Identification

OEM APPLICATIONS

Lab automation & biomedical analysis machines, self-service kiosks, automatic teller machines, game and lottery machines

MATRIX 120™



Matrix 120 is the most compact industrial 2D imager in the market to fit any integration space and the smallest compact 2D imager with embedded Ethernet connectivity.

Matrix 120 leads the market for Customer Ease of Use and is characterized by top Industrial grade in its class. With only few models, Matrix 120, covers all the target application in OEM and Entry Level Manufacturing industry.

Matrix 120 is the entry level solution of the most complete high performance industrial 2D imager range (Matrix Series) in the ID market.

FEATURES & BENEFITS

- Ultra compact dimensions for easy integration
- WVGA – 1,2MP Models and Wide angle model
- Embedded Ethernet connectivity
- Serial and USB on the same model
- ESD Version
- Polarized Version
- Outstanding performance
- Smart user selectable focus for high application flexibility
- Top Industrial grade: IP65, operating temperature: 0-45°C
- DL.Code for ease of setup
- Xpress, Green spot and intuitive HMI for top ease of use

APPLICATIONS

FACTORY AUTOMATION APPLICATIONS

Electronics – Track and trace PCB board manufacturing

Factory Automation: Print & Apply – label verification

Factory Automation: Food & Beverage – traceability

OEM: Kiosks – ticketing machine

Healthcare: Clinical Lab – vials identification

2D IMAGERS



TC1200



MATRIX 120™

READING RANGE	50-450 mm (1.97-17.72 in)	25-220mm (0.98 - 8.66 in)
MAX RESOLUTION	up to 0.10mm (4 mils)	up to 0.076mm (3 mils) - MP model
FRAME RATE / SCAN RATE	320 scans/s	up to 57 full-frame/s (WVGA model) , up to 36 full-frame/s (MP model)
FOCUSING SYSTEM	NO	Manual adjustment in three precalibrated positions (45, 70, 125mm - WVGA ; 45, 80, 125mm - MP)
SENSOR	Linear CCD Technology	CMOS sensor with Global Shutter WVGA - 752x480, MP - 1280x960
READABLE CODES	EAN/UPC, Code 39, Code 32, Code 128, GS1-128, ISBT 128, Interleaved and Standard 2 von 5, Codabar, ABC Codabar, GS1 Databar (Omnicod, Limited, Expanded), Code 93, Code 11, MSI	1D Codes: all standard 1 dimensional symbologies 2D Codes: Data Matrix, QR Code, Micro QR, Maxicode, Aztec Postal Codes: Royal Mail, Japan Post, Planet, Postnet and many more
CODE ORIENTATION	NO	Omnidirectional on any code type
MULTILABEL/MULTICODE READING	up to 10 different symbologies during the same reading phase	YES
VOLTAGE SUPPLY/POWER CONSUMPTION	5 VDC-1.75 W	5-30 VDC; 1.6 - 2.4W
IP RATING	IP64	IP65
TEMPERATURE RANGE	0 to 50 °C	0 to 45 °C
CASE MATERIAL	ABS Industrial Enclosure	Zama (Zinc Alloy) Plastic protective window cover
DIMENSIONS (TYPICAL VALUE)	57x31x50 mm (2.24x1.22x1.97 in)	45.4 x 23.5 x 29 mm (SER+USB model) 45.4 x 23.5 x 42.9 mm (SER+ETH model)
WEIGHT	105-120 g	116 gr (SER+USB model) 199 gr (SER+ETH model)
ESD SAFE	NO	YES
EMBEDDED COMMUNICATION INTERFACES	RS232 or USB	RS232/RS422 USB 2.0 (USB-CDC, USB-HID) Ethernet 10/100
FIELDBUS	NO	Profinet I/O Embedded Additional fieldbus available with CBX & QLM accessories
ETHERNET	NO	Embedded (SER+ETH model only)
XPRESS INTERFACE	NO	YES
DIGITAL INPUTS	One (trigger input), optocoupled, polarity, insensitive	Two SW Programmable (PNP/NPN)
DIGITAL OUTPUTS	Two (software programmable), optocoupled, MAX Voltage=30V, MAX Current=30mA	Two SW Programmable (PNP/NPN)
DEVICE PROGRAMMING	Aladdin SW and Programming Bar Code Labels	Windows™ based SW DL.CODE™

MATRIX 210N™



Datalogic's Matrix 210N™ offers extreme reading performance and integrated Ethernet, Ethernet/IP and PROFINET in an ultra-compact housing.

With a WVGA image sensor able to capture up to 60 frames per second, and a flexible and powerful illuminator, the Matrix 210N™ offers best-in-class direct part marked bar code reading capabilities. The unrivaled decoding libraries running on the high speed hardware platform deliver superior reading performance and impressive decoding rates, supporting high system throughput which delivers overall production efficiency.

Compact dimensions with straight or right angle optical options and electronic variable focus option, provides superb contact reading capability and a simple mechanical integration into tight spaces.

Installation and maintenance are extremely easy with the X-PRESS™ Interface. The Green Spot - projected onto the scanned object – provides easy and real-time feedback of the reading status without any additional software or accessories.

FEATURES & BENEFITS

- Integrated Ethernet, PROFINET, EtherNet/IP, interfaces
- Electronic Focus Control
- Straight and right angle models for smart mounting
- Outstanding decoding capability on DPM and labeled 1D & 2D standard codes
- On-board image saving
- ID-NET™ reader clustering/networking
- Ultra-fast image acquisition for high speed production lines
- Industrial Protection: ESD-safe, YAG, IP65

APPLICATIONS

FACTORY AUTOMATION APPLICATIONS

Electronic & Automotive: Traceability in assembly and final test, Parts and components tracking

Pharmaceutical, Food & Beverage: Supply chain traceability, Pharmaceutical manufacturing and packaging, Code Compliance check

OEM: Chemical & Biomedical Analysis Machines, Access control systems, Print & Apply systems

MATRIX 300N™



The Matrix 300N™ is an ultra-compact image based bar code reader designed for performance on high speed and Direct Part Marking (DPM) applications.

The Matrix 300N™ is powered by the new software DL.CODE, offering maximum customer ease of use.

The Matrix 300N™ combines a high resolution sensor with ultra-fast image acquisition: 1.3 megapixels, 60 frames per second.

Matrix 300N™ features a large variety of optical models, with manual focus position control or electronic.

FEATURES & BENEFITS

- Fast and high resolution image sensor: 1.3 megapixels, 'true' 60 frame/s
- Ultra-compact reader, rotating connector system
- High performance DPM reading
- Profinet-IO communication embedded
- Both manual and electronic focus control option
- Integrated dual illuminator: dark field/bright field
- Polarized model available
- Packtrack 2D for short object gapping
- Power over Ethernet Option
- Extreme Industrial grade: IP67, 0-50°C operating temperature
- Precise dual laser aiming system

APPLICATIONS

FACTORY AUTOMATION APPLICATIONS

Manufacturing, Electronics and Automotive: DPM code validation after marking, - Work-in-progress control, Parts and assemblies traceability

Food & Beverage: Work-in-progress traceability, High speed process control

Automated Warehouse: End-of-Line traceability, Reusable totes identification

Medical: Medical device traceability

Clinical Lab Automation: Biomedical analysis machines, Specimen collection machine

2D IMAGERS



MATRIX 210N™

30 - 190 mm
(1.2 - 7.5 in)

Fixed or Variable, Electronic focus control model

CMOS sensor with Global Shutter
WVGA - 752x480

60 frames/s @full window size

128 MB

1D Codes: all standard 1 dimensional symbologies
2D Codes: Data Matrix, QR Code, Micro QR, Maxicode, Aztec
Postal Codes: Royal Mail, Japan Post, Planet, Postnet and many more

Omnidirectional on any code type

YES

10 VDC to 30 VDC-4.5 W

IP65

0° to 50° C (32 to 122 °F)

Aluminum, plastic protective window cover

Straight optic
50 x 25 x 45 mm
(1.97 x 0.98 x 1.77 in)
Right angle optic
54 x 32 x 45 mm
(2.13 x 1.26 x 1.77 in)

204 g. (7.2 oz.) with cable

YES, with ESD Safe front cover accessory

YES, with YAG cut filter accessory

EMBEDDED COMMUNICATION INTERFACES

RS232/RS422/RS485
USB 2.0 in RS232 MODE
Ethernet 10/100

ID-NET INTERFACE

YES

FIELDBUS

YES
Profinet I/O Embedded
Additional fielbus available with CBX & QLM accessories

ETHERNET

YES
Embedded

XPRESS INTERFACE

YES

DIGITAL INPUTS

Two opto-isolated. Polarity insensitive and SW Programmable.

DIGITAL OUTPUTS

Two SW programmable optocoupled

DEVICE PROGRAMMING

Windows™ based SW (DL.CODE™) via Ethernet



MATRIX 300N™

25 - 450 mm
(1.2 - 19.7 in)

Electronic for liquid lens model (LQL-9MM)

CMOS sensor, Global Shutter
SXGA - 1280x1024 - 1.3 MP

60 frames/s @full window size

256 MB

1D Codes: all standard 1 dimensional symbologies
2D Codes: Data Matrix, QR Code, Micro QR, Maxicode, Aztec
Postal Codes: Royal Mail, Japan Post, Planet, Postnet and many more

Omnidirectional on any code type

YES

Std 5-30 VDC
PoE 48 VDC; 5 - 8 W

IP67

0 to 50 °C (32 to 122 °F)

Aluminum, Plastic protective window cover

95 x 54 x 43 mm (3.74 x 2.13 x 1.69 in)

485g (17 oz.) with lens and internal illuminator

YES

YES

EMBEDDED COMMUNICATION INTERFACES

RS232/RS422/RS485
Ethernet 10/100

ID-NET INTERFACE

YES

FIELDBUS

YES
Profinet I/O Embedded
Additional fielbus available with CBX & QLM accessories

ETHERNET

YES
Embedded

XPRESS INTERFACE

YES

DIGITAL INPUTS

Two opto-isolated. Polarity insensitive and SW Programmable.

DIGITAL OUTPUTS

Three SW programmable PNP/NPN (short circuit protection)
OUT3 programmable as input too

DEVICE PROGRAMMING

Windows™ based SW (DL.CODE™) via Ethernet

2D IMAGERS

MATRIX 410N™



Matrix 410N™ is an industrial 2D imager purpose-built for the most complex traceability applications in material handling and logistics, equipped with an ultra-fast image sensor that performs at 2.0 megapixels with a frame rate of 45 frames per second.

The Matrix 410N™ offers multiple communication options for increase flexibility and cost-effectiveness. The industrial imager offers Ethernet connectivity embedded, including standard communication such as TCP/IP, HTTP, FTP, as well as common industrial fieldbus communication protocols, like PROFINET IO, EtherNet/IP, Modbus TCP/IP.

FEATURES & BENEFITS

- Patented ultra-fast strobed lighting with stable effect for operator
- Patent Pending Packtrack 2D for short object gapping in sortation applications
- Embedded Ethernet connectivity, with common protocol support: PROFINET IO, ETHERNET/IP, TCP/IP, FTP, HTTP
- On board image storage saving up to 3,000 image (scaled)
- External connection box with parameter back up memory and display
- Increased flexibility with single reading point or multiple device cluster with easy configuration
- Laser pointing system, good read Green Spot, focusing aiming system
- Remote, web-based WebSentinel™ PLUS software with image archiving database

APPLICATIONS

- FACTORY AUTOMATION APPLICATIONS**
- Distribution & Retail:** Manual Presentation, Small Objects Sorting, Totes content scanning
- Warehouse:** End of line, Carton/objects, single or multi-side scanning
- Automotive:** Part traceability in assembly
- Medical & Pharmaceutical:** Automated storage/retrieval, Automated Order fulfillment/validation

MATRIX 450N™



The MATRIX 450N™ is a high-end, industrial 2D reader designed for transportation and logistics applications. With an extraordinary acquisition rate at very high resolution and a high intensity illuminator, the Matrix 450N™ is the ideal product for automated and material handling. Through its 5 million pixels captured 15 times second, the MATRIX 450N™ can be implemented in a range of applications never before solved by a 2D Imager. This 2D reader provides a large reading area in a single shot, resulting in high throughput and maximum ease of use – eliminating the need for multiple reading attempts.

FEATURES & BENEFITS

- Gigabit Ethernet integrated connectivity
- Adjustable focus through C-Mount lenses
- White and blue lighting options
- Continuous, no-flashing lighting
- Colored spot indicators
- Region of interest window for higher frame rate
- X-PRESS™ for easy and intuitive setup
- ID-NET™ embedded high speed connectivity

APPLICATIONS

- Manual Postal Sorting
- Loading/Unloading
- Postal Sorting
- Multimedia and Flats
- Induction Lines
- Order Fulfillment
- Reverse Logistics
- Static Scan

XRF410N™



The XRF410N™, named for its extended Reading Field, is a solution based on the new Matrix 410N™ platform for material handling and sortation in the logistics industry. XRF410N™ is designed and built for a broad variety of material handling applications with transportation speeds up to 2.2 m/s (433 fpm) for medium sized objects, with typical scanning depths of 400 mm (15.7 in.). The XRF410N™ is the perfect solution for e-commerce small object automated order fulfillment systems or postal logistics flats sortation applications.

FEATURES & BENEFITS

- Easy to select the correct model: no technical analysis is required. Just code dimension, conveyor width and speed
- Easy to install: the XRF410N™ is pre-assembled and configured at the factory
- Increase customer productivity: XRF410N™ is fully capable of successfully scan hard-to-read, damaged or poor quality codes.
- DL.Code for ease of setup
- Patented Packtrack 2D for short object gapping in sortation applications
- Laser pointing system, good read Green Spot, focusing aiming system

APPLICATIONS

- E-Commerce
- General material handling with reusable totes
- End-of-line
- Postal Sorting
- Medium object sortation for couriers

2D IMAGERS



	MATRIX 410N™	MATRIX 450N™	XRF410N™
READING DISTANCE (MIN / MAX)	50-2000 mm (1.97 - 78.74 in)	300-3000 mm (11.81 - 118.11 in)	860-1670 mm
FOCUSING SYSTEM	Variable Focus	Variable Focus	Variable Focus
SENSOR	CMOS sensor SXGA (1280 x 1024) 1.3 MP CCD sensor UXGA (1600x1200) 2 MP	CCD sensor 5 MP (2448 x 2050)	CMOS sensor SXGA (1280 x 1024) 1.3 MP CCD sensor UXGA (1600x1200) 2 MP
FRAME RATE	CMOS: 60 frames/s CCD: 45 frames/s	15 frames/s	CMOS: 60 frames/s CCD: 45 frames/s
ON BOARD MEMORY	256 MB	512 MB	256 MB
READABLE CODES	1D and Stacked: IL 2/5, Code 128, Code 39, EAN/UPC, PDF417, Micro PDF417, Pharmacode, GS1 DataBar (RSS) family, and many more. 2D: Data Matrix, QR Code, Micro QR, Maxicode, Aztec, Microglyph Postal: Royal Mail, Japan Post, Planet, Postnet and many more	1D and Stacked: IL 2/5, Code 128, Code 39, EAN/UPC, PDF417, Micro PDF417, Pharmacode, GS1 DataBar (RSS) family, and many more. 2D: Data Matrix, QR Code, Micro QR, Maxicode, Aztec, Microglyph Postal: Royal Mail, Japan Post, Planet, Postnet and many more	1D and Stacked: IL 2/5, Code 128, Code 39, EAN/UPC, PDF417, Micro PDF417, Pharmacode, GS1 DataBar (RSS) family, and many more. 2D: Data Matrix, QR Code, Micro QR, Maxicode, Aztec, Microglyph Postal: Royal Mail, Japan Post, Planet, Postnet and many more
CODE ORIENTATION	Omnidirectional on any code type	Omnidirectional on any code type	Omnidirectional on any code type
MULTILABEL/MULTICODE READING	YES	YES	YES
VOLTAGE SUPPLY / POWER CONSUMPTION OR CURRENT ABS.	10 to 30 VDC; 5 - 8 W	24 VDC; 2.5 A	10 to 30 VDC; 5 - 8 W
IP RATING	IP67	IP65	IP67
TEMPERATURE RANGE	0 to 50 °C (32 to 122 °F)	0 to 50 °C (32 to 122 °F)	0 to 50 °C (32 to 122 °F)
CASE MATERIAL	Aluminum	Aluminum	Aluminum
DIMENSIONS (TYPICAL VALUE)	123 x 60.5 x 87 mm (4.84 x 2.38 x 3.42 in)	170 x 200 x 150 mm (6.69x7.87x5.90 in)	320x230x166.5 mm (12.6x9x6.55 in); a capo. 320x242.75x167.5 mm (12.6x9.55x6.59 in)
WEIGHT	482g (17 oz.) with lens and internal illuminator	3 kg (105.8 oz) with lens	from 3600 g to 4920 g
ESD SAFE	YES (with accessories)	NO	YES
YAG LASER PROTECTION	YES (with accessories)	NO	YES
EMBEDDED COMMUNICATION INTERFACES	RS232 / RS422 / RS485 Ethernet IEEE 802.3 10 Base T and IEEE 802.3U 100 BaseTX compliant	RS232 / RS422 / RS485 Ethernet IEEE 802.3z 1000 BaseT compliant	RS232 / RS422 / RS485 Ethernet IEEE 802.3 10 Base T and IEEE 802.3U 100 BaseTX compliant
ID-NET™ INTERFACE	YES	YES	YES
FIELDBUS	YES Profinet I/O Embedded Additional fieldbus available with CBX & QLM accessories	YES CBX, QLM external devices	Profinet I/O Embedded Additional fieldbus available with CBX & QLM accessories
ETHERNET	YES Embedded	YES Embedded	YES Embedded
XPRESS INTERFACE™	YES	YES	YES
DIGITAL INPUTS	Two SW programmable, optocoupled and polarity insensitive	Two SW programmable, optocoupled and polarity insensitive	Two SW programmable, optocoupled and polarity insensitive
DIGITAL OUTPUTS	Three SW programmable, optocoupled	Two SW programmable, optocoupled	Two SW programmable optocoupled + one non-optocoupled
DEVICE PROGRAMMING	X-PRESS™ Human Machine Interface Windows™ based SW (DL.CODE™) Serial Host Mode Programming sequences	X-PRESS™ Human Machine Interface Windows™ based SW (DL.CODE™) Serial Host Mode Programming sequences	Windows™ based SW DL.CODE™

LASER SCANNERS

DS1100



The DS1100 embedded bar code reader is a cost-effective laser scanner characterized by ultra-compact dimensions, motor on/off software commands, wide reading width at a short reading distance, lightweight design (<100 g), built-in RISC decoder, scanning speed of 500scans/sec, dual high speed serial interface, and IP65 rugged industrial housing.

FEATURES & BENEFITS

- Straight and 90° output window
- 2 inputs + 2 outputs
- RS232 + RS485 serial port
- Winhost programming tool
- Typical reading range of 50 - 200mm

APPLICATIONS

FACTORY AUTOMATION APPLICATIONS

Electronics: WIP Control, Test Tracking, Parts Traceability and Control

Automotive: WIP Control, Parts Traceability

Food & Beverage: Label Print and Check

Pharmaceutical: Primary Package Verification, Track and Trace

OEM APPLICATIONS

Biomedical analysis machines, Automatic Teller Machines

DS1500



The combination of extremely compact dimensions and powerful high speed reading capabilities makes the DS1500 scanner ideal for demanding OEM applications. The miniature size of the DS1500 allows for easy integration into OEM equipment and automatic machinery. The high scan rate and sophisticated electronic design ideal for difficult reading conditions.

FEATURES & BENEFITS

- Scan Frequency: 800-1200scan/sec
- 1 input + 2 outputs
- RS232 + RS232 or RS485 serial port
- Typical reading range of 50 - 200mm

APPLICATIONS

FACTORY AUTOMATION APPLICATIONS

Electronics: Pick and Place Machine, WIP Control, Test Tracking, Parts Traceability and Control

Automotive: WIP Control, Parts Traceability

Food & Beverage: Label Print and Check

Pharmaceutical: Primary Package Verification, Track and Trace

Warehousing: Print & Labeling Process Verification

OEM APPLICATIONS

Packaging machines, biomedical analysis machines, document handling machines

DS2200



The DS2200 embedded bar code scanner is an ultra-compact laser scanner with a built-in decoder, that can perform 500 scans per second at a reading distance ranging from 50 to 220 mm. DS2200 scanner is a cost effective solution for OEM applications.

FEATURES & BENEFITS

- Excellent reading capabilities
- Purpose-built for OEM integration
- Very high density code reading (up to 0.076 mm / 3 mils)

APPLICATIONS

FACTORY AUTOMATION APPLICATIONS

Electronics: Pick and Place Machine, WIP Control, Test Tracking, Parts Traceability and Control

Automotive: WIP Control, Parts Traceability

Food & Beverage: Label Print and Check

Pharmaceutical: Primary Package Verification, Track and Trace

Warehousing: Print & Labeling Process Verification

OEM APPLICATIONS

Biomedical analysis machines, document handling machines

LASER SCANNERS



	DS1100	DS1500	DS2200
READING DISTANCE (MIN / MAX)	100 - 220 mm (3.94 - 8.66 in)	100-240 mm (3.94 - 9.45 in)	50 - 220 mm (2.0 - 8.66 in)
MAX RESOLUTION	up to 0.12mm (5 mils)	up to 0.10mm (4mils)	up to 0.076mm (3mils)
SCAN RATE	500 scans/s	800-1200 scans/s	500 scans/s
SCAN PATTERN TYPE	Linear / Raster	Linear	Linear / Raster
APERTURE ANGLE	70 degrees	60 degrees	62 degrees
MULTILABEL READING	Up to 6 different symbologies during the same reading phase	Up to 6 different symbologies during the same reading phase	Up to 6 different symbologies during the same reading phase
RECONSTRUCTION CODE TECHNOLOGY	NO	ACB™ embedded	NO
READABLE CODES	Code 2/5, Code39, Code93, Code128, EAN/UPC, EAN128, Codabar, Pharmacode	Code 2/5, Code39, Code93, Code128, EAN/UPC, EAN128, Codabar, Pharmacode	Code 2/5, Code39, Code93, Code128, EAN/UPC, EAN128, Codabar, Pharmacode
CASE MATERIAL	Magnesium (body) + Polycarbonate (cover)	Zama (zinc, aluminum, magnesium alloy)	Die-cast Zinc
DIMENSIONS (TYPICAL VALUE)	80 x 50 x 22 mm (3.15 x 1.97 x 0.89 in)	40 x 30 x 22 mm (1.57 x 1.18 x 0.87 in)	50 x 40 x 28 mm (1.97 x 1.57 x 1.10 in)
WEIGHT (TYPICAL VALUE)	< 100g (3.53 oz) without cable	44g (1.55 oz) without cable	150g (5.29 oz) without cable
TEMPERATURE RANGE	0° - 45 °C (32 - 113 °F)	0° - 45 °C (32 - 113 °F)	0° - 40 °C (32 - 104 °F)
VOLTAGE SUPPLY / POWER CONSUMPTION	5 VDC - 1.5W	5 VDC - 2W	5 VDC - 2W
IP RATING	IP65	IP65	IP65
EMBEDDED COMMUNICATION INTERFACES	Main port RS485 Half Duplex up to 115.2 Kbit/s Auxiliary port RS232 up to 115.2 kbps	2 x RS232 or 1 x RS485 full or half duplex (you can select them with SW)	Main port RS485 Half Duplex up to 115.2 Kbit/s Auxiliary port RS232 up to 115.2 kbps
DIGITAL INPUTS	Two SW programmable (NPN only)	External Trigger (NPN only)	External Trigger (NPN only)
DIGITAL OUTPUTS	Two SW programmable, event driven	Two SW programmable, event driven	Two SW programmable, event driven
DEVICE PROGRAMMING	WinHost™ (Windows™ based) SW and Serial Host Mode Programming sequences	WinHost™ (Windows™ based) SW	WinHost™ (Windows™ based) SW and Serial Host Mode Programming sequences

LASER SCANNERS

DS2100N



The DS2100N industrial laser bar code reader leverages Datalogic Automation's 40-year tenure in 1D bar code reading, satisfying the demanding application needs of warehousing, shop floor and OEM applications. Equipped with limitless connectivity options including PROFINET, EtherNet/IP, and Ethernet TCP/IP communication protocols, the DS2100N is the optimal choice for short reading distances.

FEATURES & BENEFITS

- Embedded Ethernet connectivity
- Two PROFINET Ports
- Embedded Ethernet Switch
- Rotating connector block
- Compact dimensions
- Installation flexibility and optimum form factor
- Advanced Code Reconstruction (ACR)
- Excellent performance on low quality and damaged labels
- Up to 300mm (11.8 in.) reading distance

APPLICATIONS

- Automatic warehousing
- Small conveyors
- Picking systems
- Packaging machines
- Document handling machines
- Print & Apply systems
- Quality control and parts tracking

DS2400N



The DS2400N is the first-in-his-class laser bar code reader offering maximum connectivity freedom, better optic performance and ease to install in the most demanding applications including warehousing, shop floor and OEM machinery. DS2400N is optimum choice on short-medium reading distance and it is equipped with all connectivity options including PROFINET, EtherNet/IP, and Ethernet TCP/IP communication protocols.

FEATURES & BENEFITS

- Embedded Ethernet connectivity
- Two PROFINET Ports
- Embedded Ethernet Switch
- Rotating connector block
- Compact dimensions
- Installation flexibility and optimum form factor
- Advanced Code Reconstruction (ACR)
- Excellent performance on low quality and damaged labels
- Up to 600mm (23.6 in) reading distance

APPLICATIONS

- Automatic warehousing
- Small conveyors
- Picking systems
- Packaging machines
- Document handling machines
- Print & Apply systems
- Quality control and parts tracking

DS4800



The DS4800 is a flexible and compact laser scanner for industrial applications, satisfying all the identification needs of manufacturing plants. The DS4800 offers excellent reading performance, easy setup with X-PRESS™ interface, a high-speed ID-NET™ communication interface and is immune to ambient light. The DS4800 series includes Subzero models, both linear and oscillating mirror, extending its operating temperature from -35°C to 50°C through an internal heater and de-frost window.

FEATURES & BENEFITS

- Selectable focus system
- 600-900 scans /sec
- 2 inputs + 2 outputs
- RS232 + RS485 serial port
- Display and multi-language messages
- ACR4 decoding algorithm
- Typical reading range of 200 – 1000 mm
- Subzero ver. up to -35°C (-31°F)

APPLICATIONS

FACTORY AUTOMATION APPLICATIONS

- Automotive:** WIP Control, Parts Traceability
- Food & Beverage:** Shipping Process, End of Line Palletizing
- Pharmaceutical:** Secondary Package Control
- Warehousing:** Tote Tray Identification, Automatic Picking Process Control, Cold Storage Application

LASER SCANNERS



DS2100N



DS2400N



DS4800

READING DISTANCE (MIN / MAX)	50 - 300 mm (1.97 - 11.81 in)	70 - 600 mm (2.76 - 23.62 in)	200 - 1000 mm (7.87 - 39.37 in)
MAX RESOLUTION	up to 0.12mm (5 mils)	up to 0.12mm (5 mils)	up to 0.20mm (8mils)
SCAN RATE	500 - 1000 scans/s	600 - 1000 scans/s	600 - 1000 scans/s
SCAN PATTERN TYPE	Linear / Raster	Linear / Raster	Linear / Oscillating Mirror
VARIABLE FOCUS	NO	NO	YES
APERTURE ANGLE	60 degrees	60 degrees	50 degrees
MULTILABEL READING	Up to 10 Codes in the same reading phase	Up to 10 Codes in the same reading phase	Up to 10 Codes in the same reading phase
BAR CODE ASSIGNMENT TECHNOLOGY	NO	NO	NO
AUTOFOCUS / DYNAMIC FOCUS	NO	NO	NO
RECONSTRUCTION CODE TECHNOLOGY	ACR Advanced Code Reconstruction	ACR Advanced Code Reconstruction	ACR4™
READABLE CODES	Code 2/5, Code39, Code93, Code128, EAN/UPC, EAN128, Codabar, Pharmacode, Plessey, ISBT128	Code 2/5, Code39, Code93, Code128, EAN/UPC, EAN128, Codabar, Pharmacode, Plessey, ISBT128	Code 2/5, Code39, Code93, Code128, EAN/UPC, EAN128, Codabar, Pharmacode, Plessey, ISBT128
CASE MATERIAL	Aluminum	Aluminum	Aluminum
DIMENSIONS (TYPICAL VALUE)	84 x 68 x 34 mm (3.31 x 2.68 x 1.34 in)	84 x 68 x 34 mm (3.31 x 2.68 x 1.34 in)	101 x 85 x 42 mm (3.98 x 3.35 x 1.65 in)
WEIGHT	330g (11.64 oz)	330g (11.64 oz)	570g (20.11 oz)
TEMPERATURE RANGE	0° - 45 °C (32 - 113 °F)	0° - 45 °C (32 - 113 °F); Subzero ver. up to -35°C (-31°F)	0° - 50 °C (32 - 122 °F); Subzero ver. up to -35°C (-31°F)
VOLTAGE SUPPLY / POWER CONSUMPTION	10-30 VDC; 4 W (average)	10-30 VDC; 4 W (average)	10-30 VDC; 6-32 W
IP RATING	IP65	IP65	IP65
EMBEDDED COMMUNICATION INTERFACES	Main port RS232/RS422/RS485 up to 115.2 Kbit/s Auxiliary port RS232 up to 115.2 kbps	Main port RS232/RS422/RS485 up to 115.2 Kbit/s Auxiliary port RS232 up to 115.2 kbps	Main port RS232/RS422/RS485 up to 115.2 Kbit/s Auxiliary port RS232 up to 115.2 kbps
DIGITAL INPUTS	External Trigger (optocoupled, NPN/PNP), IN2 (not optocoupled, NPN only)	External Trigger (optocoupled, NPN/PNP), IN2 (not optocoupled, NPN only)	Two SW programmable, optocoupled, NPN/PNP
DIGITAL OUTPUTS	Two SW programmable, event driven, optocoupled	Two SW programmable, event driven, optocoupled	Two SW programmable, event driven, optocoupled
ID-NET™ INTERFACE	YES	YES	YES
FIELDBUS	YES with CBX , QLM external devices	YES with CBX , QLM external devices	YES with CBX , QLM external devices
ETHERNET	YES with CBX , QLM external devices	YES with CBX , QLM external devices	YES with CBX , QLM external devices
XPRESS INTERFACE™	YES	YES	YES
DEVICE PROGRAMMING	Genius™ (Windows™ based) SW Serial Host Mode Programming sequences	Genius™ (Windows™ based) SW Serial Host Mode Programming sequences	Genius™ (Windows™ based) SW Serial Host Mode Programming sequences

LASER SCANNERS

DS5100



The DS5100 is a flexible and compact laser scanner for industrial applications, satisfying all the identification needs of manufacturing plants. The DS5100 offers excellent reading performance, easy setup with X-PRESS™ interface, a high-speed ID-NET™ communication interface and is immune to ambient light. The DS5100 series includes Subzero models, both linear and oscillating mirror, extending its operating temperature from -35°C to 50°C through an internal heater and de-frost window

FEATURES & BENEFITS

- Selectable focus system
- 800-1000 scans /sec
- 2 inputs + 2 outputs
- RS232 + RS485 serial port, Ethernet, Profinet
- Display and multi-language messages
- ACR4 decoding algorithm
- Typical reading range of 200 – 1350 mm
- Subzero ver. up to -35°C (-31°F)

APPLICATIONS

FACTORY AUTOMATION APPLICATIONS

- **Automotive:** WIP Control, Parts Traceability
- **Food & Beverage:** Shipping Process, End of Line Palletizing
- **Pharmaceutical:** Secondary Package Control,
- **Warehousing:** Tote Tray Identification, Automatic Picking Process Control, Cold Storage Application

DS8110



DS8110 is the new bar code reader offering top class reading performance at any operative conditions, designed to satisfy the most demanding applications in the Parcel Sorting and Baggage Handling applications. DS8110 sets a new standard in T&L applications offering unique features and benefits. The innovative DST (Digital Signal Technology) represents a milestone in Auto-ID market with drastic increase of DoF and FoV, even with unpredictable code quality.

ASTRA™ G3, the latest version of ASTRA technology, offers outstanding performance multiplying optic capability and deep of field without any use of traditional and limited mechanical autofocus system. Multi-headed tunnel configurations are perfectly managed based with new EBC-Ethernet Bus Connection, allowing high speed data transmission and real time signal synchronization inside the system.

Ease of use, automatic setup and system diagnostics are perfectly satisfied thanks to e-GENIUS.

FEATURES & BENEFITS

- Excellent performance on low quality codes and unpredictable reading conditions
- DST (Digital Signal Technology)
- ASTRA G3 technology offering superior DoF and FoV
- Ethernet Bus Connections (EBC)
- Fully redundant configuration and no single point of failure
- Compact mechanical dimensions; lightweight
- Ease of use and ease of installation thanks e-GENIUS
- Ease of maintenance and automatic replacement

APPLICATIONS

- Airport Baggage Handling
- Parcel Sorting
- Retail Distribution Center
- Loading/Unloading System
- Shop Floor and Manufacturing
- Automatic Warehousing Management

DX8210



DX8210 is Datalogic's new high performance laser bar code reader purpose built to offer top reading performance combined and ease of use to End User and System Integrators specialized in the Transport and Logistics market.

Thanks to its unique design, DX8210 offers an ALL-IN-ONE solution for omnidirectional reading stations. DX8210 can cover a wide conveyor and large depth of field to satisfy demanding applications thanks to a high scan rate (1000 scans/sec). In just a few minutes, readers can be installed above the conveyor and the omnidirectional station is ready to work.

The innovative DST (Digital Signal Technology) drastically increases optic performance even in cases where code quality is unpredictable. Multi-headed tunnel configurations are perfectly managed with EBC (Ethernet Bus Connection). Ease of use, automatic setup and system diagnostics are perfectly satisfied thanks to e-GENIUS.

FEATURES & BENEFITS

- ALL-IN-ONE architecture offering outstanding ease of use and ease of installation
- Single device offering 900x900 mm (36x36 in) omnidirectional reading area
- High scan rate (1000 scans/sec)
- Excellent performance on low quality code and unpredictable reading conditions
- DST (Digital Signal Technology)
- ASTRA G3 technology offering superior DoF and FoV
- Ethernet Bus Connections (EBC)
- Fully redundant configuration and no single point of failure
- e-GENIUS web browser programming tools
- Ease of maintenance and automatic replacement

APPLICATIONS

- Airport Baggage Handling
- Parcel Sorting
- Retail Distribution Center
- Loading/Unloading System
- Shop Floor and Manufacturing
- Automatic Warehousing Management

LASER SCANNERS

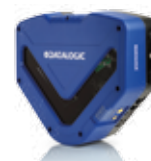

	DS5100	DS8110	DX8210
READING DISTANCE (MIN / MAX)	200 - 1350 mm (7.87-53.15 in)	500-1900 mm (20-75 in)	600-1850 mm (23-72 in)
BAR CODE RESOLUTION RANGE	up to 0.20mm (8mils)	Min:0.25mm (10mils)/ Max: 0.50mm (20mils)	Min:0.25mm (10mils)/Max: 1.0mm (40mils)
SCAN RATE	800 - 1000 scan/s	1000 scans/s/ Max	1000scans/s/ Max
SCAN PATTERN TYPE	Linear / Oscillating Mirror	Linear	X-Pattern
FOCUSING SYSTEM	YES	NO	NO
APERTURE ANGLE	50 degrees	60 degrees	60 degrees
MULTILABEL READING	Up to 10 Codes in the same reading phase	Up to 10 different symbologies during the same reading phase	Up to 10 different symbologies during the same reading phase
BAR CODE ASSIGNMENT TECHNOLOGY	Packtrack on Long range	PackTrack™ G2	PackTrack™ G2
RECONSTRUCTION CODE TECHNOLOGY	ACR4	ACR™ G5	ACR™ G5
READABLE CODES	Code 2/5, Code39, Code93, Code128, EAN/UPC, EAN128, Codabar, Pharmacoode, Plessey, ISBT128	22 symbologies including 2/5 family, Code39, Code93, Code128, EAN/UPC, EAN128, ISBN128	22 symbologies including 2/5 family, Code39,Code93,Code128,EAN/ UPC,EAN128,ISBN128
CASE MATERIAL	Aluminum	Aluminum alloy	Aluminum alloy
DIMENSIONS (TYPICAL VALUE)	101 x 85 x 42 mm (3.98 x 3.35 x 1.65 in)	216 x 96 x 127 mm [8.5 x 3.8 x 5 in]	381 x 328 x 92.5 mm [15 x 13 x 3.6 in]
WEIGHT	580 g	2.0 kg (4.4 lb)	7.7 kg (17 lb)
TEMPERATURE RANGE	0° - 50 °C (32 - 122 °F); Subzero ver. up to -35°C (-31°F)	0° - 50°C	0° - 50° C
VOLTAGE SUPPLY / POWER CONSUMPTION	10-30 VDC; 6-32 W	20 to 30 VDC; 20 W	20 to 30 VDC; 20 W
IP RATING	IP65	IP65	IP65
EMBEDDED COMMUNICATION INTERFACES	Main port RS232/RS485 Auxiliary port RS232 ID-NET RS485 multidrop EtherNet/IP , Ethernet TCP/IP, PROFINET	Main Port: RS232/RS422 up to 115.2 Kbit/s Auxiliary Port: RS232 up to 115.2 Kbit/s	Main Port: RS232 / RS422 up to 115.2 Kbit/s Auxiliary Port: RS232 up to 115.2 Kbit/s
DIGITAL INPUTS	2 Input (optocoupled, NPN/PNP)	3 x Inputs (2 + 1 x 'Encoder"), optocoupled, NPN/PNP	3 x Inputs (2 + 1 x 'Encoder"), optocoupled, NPN/PNP
DIGITAL OUTPUTS	2 Outputs (optocoupled)	2 x Outputs SW programmable, optocoupled, event driven, NPN	2 x Outputs SW programmable, optocoupled, event driven, NPN
ID-NET interface	YES	NO	NO
FIELDBUS	Model with embedded EtherNet/IP compatible with CBX , QLM external devices Model with embedded PROFINET with internal switch (2 Ports)	Embedded EtherNet/IP; PROFINET-IO and PROFIBUS-DP supported	Embedded EtherNet/IP; PROFINET-IO and PROFIBUS-DP supported
ETHERNET	Model with embedded Ethernet TCP-IP / compatible with CBX , QLM external devices Model with embedded PROFINET with internal switch (2 Ports)	2 x Ethernet TCP/IP	2 x Ethernet TCP/IP
XPRESS interface	YES	YES	YES
DEVICE PROGRAMMING	Genius™ (Windows™ based) SW Serial Host Mode Programming sequences	e-Genius web browser configuration tool	e-Genius web browser configuration tool

INDUSTRIAL HANDHELD DEVICES

PowerScan™ 9500 2D AREA IMAGER (Standard and Direct Part Marking)



The PowerScan™ PM9500 area Imager offers an intuitive and effortless scanning experience. It combines omnidirectional reading capabilities with outstanding optical characteristics. The result is a scanner that is able to read any kind of bar code, regardless of the orientation, from contact to over 1.0 m / 3.3 ft. Within the PowerScan™ 9500 family the DPM Evo models includes the latest optics and software from Datalogic to make the reading of codes with DPM easy and intuitive. The PM9500 models standard and DPM increase workplace flexibility and productivity through its STAR cordless system avoiding any interference with Wi-Fi or Bluetooth systems.

FEATURES & BENEFITS

- Datalogic's new instinctive 'frame' aimer
- Liquid Lens models capable to read high density codes as well as wide labels
- STAR cordless system: point-to-point and multi-point configurations in a seamless roaming without interference with existing radio systems
- Datalogic's Motionix™ motion-sensing technology
- Datalogic's 3GL™ (3 Green Lights) technology and loud beeper for good read feedback

APPLICATIONS

- Manufacturing Shop Floor: Work-in-Progress, Sub-Assembly, Component Tracking, Quality Control, Time and Cost Analysis
- Warehouse and Logistic Centers: Shipping / Receiving, Parcel Preparation, Picking

PowerScan™ 9300 Laser Series



The PowerScan™ P9300 reader's mechanics have been developed and tested to withstand extreme environmental conditions, maintaining consistent reading performance without degrading performance or reliability.

The PS9300 series includes different models able to satisfy all customers' needs; corded and cordless (STAR Radio or Bluetooth), with or without display 4 keys/16 keys keypad.

The Auto Range models are particular suitable for forklift applications capable to read up to 11.5 m / 37 ft on reflective codes

FEATURES & BENEFITS

- Ergonomic shape provides hours of tireless data collection for the user
- 2 Radio options STAR RADIO 2.0 or Bluetooth
- Datalogic's 3GL™ (3 Green Lights) technology and loud beeper for good read feedback
- User replaceable lithium-ion battery

APPLICATIONS

- Manufacturing Shop Floor: Work-in-Progress, Sub-Assembly, Component Tracking, Quality Control, Time and Cost Analysis
- Warehouse and Logistic Centers: Shipping / Receiving, Parcel Preparation, Picking

INDUSTRIAL HANDHELD DEVICES



PowerScan™ 9500 Series



PowerScan™ PM9300

READING DISTANCE (MIN / MAX)

0 to over 1m (0 to over 39.4 in)
depending on code resolution

Standard Range: contact up to 1.6 m / 5.2 ft
Auto Range: up to 11.5 m / 37 ft on reflective codes

SENSOR

864 x 544 (PD9530); 1280 x 1024 (PD9530-HP)

Laser

SCAN RATE

60 scan/sec

35 scan/sec

VARIABLE FOCUS

Liquid lens autofocus system

NO

READING ANGLE

Pitch: +/- 40°; Roll (Tilt): 360°; Skew (Yaw): +/- 40°

Pitch: 5 to 55° / -5 to -55°; Roll
(Tilt): +/- 20°; Skew (Yaw): +/- 60°

MULTILABEL READING

YES

NO

READABLE CODES

1D / Linear Codes: autodiscriminates all standard 1D codes including GS1 DataBar™ linear codes, 2D Codes Aztec Code; China Han Xin Code; Data Matrix; MaxiCode; Micro QR Code; QR Code, Postal Codes Australian Post; China Post; IMB; Japanese Post; KIX Post; Planet Code; Portuguese Post; Postnet; Royal Mail, Code (RM4SCC); Swedish Post, Stacked Codes, EAN/JAN Composites: GS1 DataBar Composites; GS1 DataBar Expanded Stacked; GS1 DataBar Stacked; GS1 DataBar Stacked Omnidirectional; MacroPDF; MicroPDF417; PDF417; UPC A/E Composites

GS1 DataBar™ linear codes, UPC/EAN, UPC/EAN P2/P5 add ons, UPC/EAN Coupons, ISBN, Code 128, EAN 128, Code 39, Code 39 Full ASCII, Code 39 CIP, Code 32, Codabar, Interleaved 2 of 5, IATA, Industrial 2 of 5, Standard 2 of 5, Code 11, MSI, Plessey, Code 93, Follet 2/5, Code 4, Code 5, Datalogic 2 of 5, Codablock F
PBT9300-ARXX GS1 DataBar™ linear codes, UPC/EAN, UPC/EAN P2/P5 add ons, UPC/EAN Coupons, ISBN, Code 128, EAN 128, Code 39, Code 39 Full ASCII, Code 32, Codabar, Interleaved 2 of 5, Standard 2 of 5, MSI, Code 93

CASE MATERIAL

ABS

ABS

DIMENSIONS (TYPICAL VALUE)

212 x 110 x 74 mm (8.3 x 4.3 x 2.9 in)

212 x 110 x 74 mm (8.3 x 4.3 x 2.9 in)

WEIGHT

330.0 g (11.6 oz)

295.0 g (10.4 oz)

TEMPERATURE RANGE

Operating: -20 to 50 °C / -4 to 122 °F

Operating: -20 to 50 °C / -4 to 122 °F

VOLTAGE SUPPLY
/ CURRENT ABSORPTION

5 VDC +/- 10% 335 mA (PD9530/PD9530-HP)
10 VDC; 800 mA (PM9500/PBT9500 cradle)

5 VDC +/- 10% 335 mA (PD9530/PD9530-HP)
10 VDC; 800 mA (PM9500/PBT9500 cradle)

IP RATING

IP65

IP65

MODELS (OPTIC OPTIONS)

Standard, HP (liquid lens autofocus); DPM

Standard, Autorange

MODELS (COMMUNICATION OPTION)

Corded, Cordless
(Datalogic STAR 2.0 Cordless System)

Corded, Cordless
(Datalogic STAR 2.0 Cordless System)

EMBEDDED
COMMUNICATION INTERFACES

USB, RS232, KBD emulation
INDUSTRIAL ETHERNET and RS485
(PM9500/PBT9500 cradle)

USB, RS232, KBD emulation
INDUSTRIAL ETHERNET and RS485
(PM9500/PBT9500 cradle)

RADIO RANGE (CORDLESS MODELS)

up to 100 m (STAR RADIO 433MHz)
up to 150 m (STAR RADIO 910MHz)

up to 100 m (STAR RADIO 433MHz)
up to 150 m (STAR RADIO 910MHz)

ETHERNET

On the cradle for the cordless model

On the cradle for the cordless model

DEVICE PROGRAMMING

barcode, Aladdin

barcode, Aladdin

LINEAR IMAGERS

AV7000™



AV7000 is the innovative linear camera setting a new paradigm in the T&L market.

AV7000 is characterized by superior optic performance, extended Auto-ID capabilities, advanced SW functions for image elaboration and data archiving, with excellent tools for operational analysis and process optimization. Combining the benefits of a next generation CMOS sensor with 40% greater sensitivity and exclusive Datalogic patented technologies, the new AV7000 provides High Definition Images and software functionality that exceed customer expectations.

With a large Field of View (1400 mm -55 inch), the AV7000 is the perfect solution to collect High Definition images in a single picture on a large conveyor, instead of multiple partial pictures.

Thanks to Pulsed Lighting Systems – a Datalogic patented technology – a multi-sided AV7000 reading station now requires 50% less space than a nonpulsed lighting system for applications that demand a smaller footprint. The AV7000 camera system is ideal for the most demanding applications in Parcel Sorting for Express Courier and Retail Distribution Company.

FEATURES & BENEFITS

- Next generation CMOS sensor with 40 % greater sensitivity
- Single view high quality picture for large conveyors (1400 mm/55 inch)
- Patented Autofocus System offering extended DoF
- Patented PLS technology technology, reducing the footprint of the reading station by 50%
- Patented Digital Zoom technology assuring constant DPI resolution
- Next generation decode algorithm for poor quality codes
- Multiple format image saving from full definition to highly compressed JPG
- Browser based interface compatible with any kind of OS and HW platform including PC and Tablet
- Redundant architecture with no single point of failure
- Software tools for image saving and data intelligence
- Linux operative system

APPLICATIONS

- Parcel sorting
- Dimension Weigh Scan System
- OCR and Videocoding
- Extended ID and image saving

LINEAR IMAGERS

FIELD OF VIEW
MAX RESOLUTION
SCAN RATE
OCR & VIDEO-CODING FUNCTIONS
IMAGER SENSOR FEATURES
MULTILABEL READING
READABLE CODES
VOLTAGE SUPPLY / POWER CONSUMPTION
IP RATING
TEMPERATURE RANGE
CASE MATERIAL
DIMENSIONS
WEIGHT
EMBEDDED COMMUNICATION INTERFACES
DIGITAL INPUTS
DIGITAL OUTPUTS
IMAGE SAVING FUNCTION
ETHERNET
DEVICE PROGRAMMING
TUNNEL CONFIGURATIONS
MODULATED LIGHT TECHNOLOGY
DIMENSIONING FUNCTION



AV7000™	
FIELD OF VIEW	up to 1400 mm (55.12 in)
MAX RESOLUTION	110 - 260 DPI (application dependant)
SCAN RATE	33000 scans/s (33 kHz)
OCR & VIDEO-CODING FUNCTIONS	YES
IMAGER SENSOR FEATURES	Linear CMOS 8K sensor (8192 pixels)
MULTILABEL READING	YES
READABLE CODES	All Standard 1D & 2D symbologies
VOLTAGE SUPPLY / POWER CONSUMPTION	24 VDC; 360 - 450 W
IP RATING	IP65
TEMPERATURE RANGE	0 to 50 °C (32 to 122 °F)
CASE MATERIAL	Aluminum die-casting
DIMENSIONS	SHORT: 845 x 400 x 237 mm (33.27 x 15.75 x 9.33 in) MED: 1150 x 400 x 237 mm (45.28 x 15.75 x 9.33 in) LONG: 1480 x 400 x 237 mm (58.27 x 15.75 x 9.33 in)
WEIGHT	11 kg (24.25 lb)
EMBEDDED COMMUNICATION INTERFACES	Dual USB port, VGA port, Ethernet Gb, RS232/RS485 full duplex up to 115.2 Kbit/s (optoisolated)
DIGITAL INPUTS	Presence sensor input, speed sensor input
DIGITAL OUTPUTS	1 Output NPN or PNP open collector input/output, optoisolated for each camera
IMAGE SAVING FUNCTION	YES
ETHERNET	YES Embedded
DEVICE PROGRAMMING	VCS Supervisor SW provides diagnostics and statistics with a very intuitive visual on screen information
TUNNEL CONFIGURATIONS	From 1-side to 6-sides configurations
MODULATED LIGHT TECHNOLOGY	YES
DIMENSIONING FUNCTION	YES with external device

2D IMAGERS MULTIPLE HEADS SOLUTIONS

STS400™



STS400™ is a state-of-the-art solution for tire sorting. With an extremely compact and self-contained structure, this solution excels in delivering top reading performance with simple, user-friendly installation and maintenance. STS400™ is pre-assembled and calibrated, making integration into a tire sorting system quicker than ever. In less than one hour, with no special tools or training, the STS400™ can go from the shipping carton to reading tires in the production line.

FEATURES & BENEFITS

- Easy to install (100% pre-assembly calibration) and maintain
- Simple and lean: regulated render layout, eliminating articulated mounting patterns
- Long-term reliability with no moving on-board
- Compatible with changing requirements, such as code heights and cd codes

APPLICATIONS

- FACTORY AUTOMATION APPLICATIONS**
- Tires:** Final Inspection, Sorting & Shipping, Final Finishing and Inspection, Curing Process Control, Labeling Verification
- Pharmaceutical:** Secondary Package Control
- Warehousing:** Sorting and Shipping Process

2D IMAGERS MULTIPLE HEADS SOLUTIONS

READING DISTANCE (MIN / MAX)
READING WIDTH mm (inch) n° 6 HEADS
READING WIDTH mm (inch) n° 7 HEADS
READING WIDTH mm (inch) n° 8 HEADS
SENSOR
FRAME RATE
MAX RESOLUTION
READABLE CODES
CODE ORIENTATION
MULTILABEL/MULTICODE READING
VOLTAGE SUPPLY / CURRENT ABSORPTION
IP RATING
TEMPERATURE RANGE
CASE MATERIAL
ARRAY OVERALL DIMENSIONS (TYPICAL VALUE)
WEIGHT
EMBEDDED COMMUNICATION INTERFACES
ID-NET™ INTERFACE
FIELDBUS
ETHERNET
XPRESS INTERFACE™
DIGITAL INPUTS
DIGITAL OUTPUTS
DEVICE PROGRAMMING



STS400™- Passenger Light Truck Tires

READING DISTANCE (MIN / MAX)	890 - 1140 mm (35 - 44.9 in)
READING WIDTH mm (inch) n° 6 HEADS	945 mm (37.2 in)
READING WIDTH mm (inch) n° 7 HEADS	1085 mm (42.7 in)
READING WIDTH mm (inch) n° 8 HEADS	1225 mm (48.2 in)
SENSOR	CCD sensor UXGA (1600x1200) 2 MP
FRAME RATE	15 frames / s
MAX RESOLUTION	0.30mm (12 mils)
READABLE CODES	1D and Stacked: IL 2/5, Code 128, Code 39, Code 32, MSI, Std 2 of 5, Matrix 2 of 5, Interleaved 2 of 5, Codabar, Code 93, EAN/UPC, PDF417, Micro PDF417, Pharmacode, GS1 DataBar (RSS) family, Composite Symbologies 2D: Data Matrix ECC200, QR Code, Micro QR, Maxicode, Aztec Code Postal: Australia Post, Royal Mail 4 State Customer, Kix Code, Japan Post, Planet, Postnet, Intelligent Mail, Swedish Post
CODE ORIENTATION	Omnidirectional on any code type
MULTILABEL/MULTICODE READING	YES
VOLTAGE SUPPLY / CURRENT ABSORPTION	24 VDC ; 1.35 A
IP RATING	IP65
TEMPERATURE RANGE	0 - 50 °C (32 - 122 °F)
CASE MATERIAL	Aluminum
ARRAY OVERALL DIMENSIONS (TYPICAL VALUE)	STS400-006: 785 x 223 x 149 mm (30.91 x 8.78 x 5.87 in.)
WEIGHT	STS400-006: 10 kg (22.05 lb)
EMBEDDED COMMUNICATION INTERFACES	RS232/RS422/RS485 Ethernet IEEE 802.3 10 Base T and IEEE 802.3U 100 BaseTX compliant
ID-NET™ INTERFACE	YES
FIELDBUS	YES Available with external device
ETHERNET	YES Embedded
XPRESS INTERFACE™	YES
DIGITAL INPUTS	Input 1 (External Trigger) Input 2 Opto-coupled and polarity insensitive
DIGITAL OUTPUTS	Output 1 and Output 2 Opto-coupled
DEVICE PROGRAMMING	Windows™ based SW (DL.CODE™) Serial Host Mode Programming sequences



STS400™- Commercial Vehicle Tires

READING DISTANCE (MIN / MAX)	880 - 1280 mm (34.6 - 50.4 in)
READING WIDTH mm (inch) n° 6 HEADS	945 mm (37.2 in)
READING WIDTH mm (inch) n° 7 HEADS	1085 mm (42.7 in)
READING WIDTH mm (inch) n° 8 HEADS	1225 mm (48.2 in)
SENSOR	CCD sensor UXGA (1600x1200) 2 MP
FRAME RATE	15 frames / s
MAX RESOLUTION	0.35mm (14 mils)
READABLE CODES	1D and Stacked: IL 2/5, Code 128, Code 39, Code 32, MSI, Std 2 of 5, Matrix 2 of 5, Interleaved 2 of 5, Codabar, Code 93, EAN/UPC, PDF417, Micro PDF417, Pharmacode, GS1 DataBar (RSS) family, Composite Symbologies 2D: Data Matrix ECC200, QR Code, Micro QR, Maxicode, Aztec Code Postal: Australia Post, Royal Mail 4 State Customer, Kix Code, Japan Post, Planet, Postnet, Intelligent Mail, Swedish Post
CODE ORIENTATION	Omnidirectional on any code type
MULTILABEL/MULTICODE READING	YES
VOLTAGE SUPPLY / CURRENT ABSORPTION	24 VDC ; 1.71 A
IP RATING	IP65
TEMPERATURE RANGE	0 - 50 °C (32 - 122 °F)
CASE MATERIAL	Aluminum
ARRAY OVERALL DIMENSIONS (TYPICAL VALUE)	STS400-106: 800 x 241 x 176 mm (31.50 x 9.49 x 6.93 in)
WEIGHT	STS400-106: 10 kg (22.05 lb)
EMBEDDED COMMUNICATION INTERFACES	RS232/RS422/RS485 Ethernet IEEE 802.3 10 Base T and IEEE 802.3U 100 BaseTX compliant
ID-NET™ INTERFACE	YES
FIELDBUS	YES Available with external device
ETHERNET	YES Embedded
XPRESS INTERFACE™	YES
DIGITAL INPUTS	Input 1 (External Trigger) Input 2 Opto-coupled and polarity insensitive
DIGITAL OUTPUTS	Output 1 and Output 2 Opto-coupled
DEVICE PROGRAMMING	Windows™ based SW (DL.CODE™) Serial Host Mode Programming sequences

DM3610



The DM3610 is an ultra-high performance, in-motion, overhead dimensioning unit that automatically measures the length, width, and height of packages as they are transported on a conveyor. The DM3610 is certified in legal-for-trade applications and performs highly accurate measurements, making it perfect solution for spatial management applications.

FEATURES & BENEFITS

- Accuracy of $\pm 5\text{mm}$ (0.2in) at transport speeds up to 3.1 m/s (620 fpm)
- Exclusive Find-Belt functionality allows for 'one button' setup and plug-and-play operation
- Simple parameter backup and upload simplifies field replacement

APPLICATIONS

FACTORY AUTOMATION APPLICATIONS

Warehousing: Sorting and Shipping Process

TRANSPORTATION AND LOGISTICS APPLICATIONS

Revenue recovery for Courier/Express/Parcel, trailer load planning, automated manifesting systems, side-by-side package detection, airports out-of-gauge baggage check

DIMENSIONER



DM3610-1 Head System

DM3610-2 Head System

MATERIAL FLOW

singulated, cuboidal, gap ≥ 20 mm (.08")

singulated, irregular, gap ≥ 25 mm (1")

DIMENSIONING ACCURACY
(NTEP, OIML)

± 0.2 " for length and width and ± 0.1 " for height
 ± 5 mm for length, width and height

± 0.2 " for length and width and ± 0.1 " for height
 ± 5 mm for length, width and height

MAX CONVEYOR SPEED

up to 3.1m/s

up to 3.1m/s

CASE MATERIAL

Aluminum

Aluminum

MAX PARCEL DIMENSIONS

2500 x 1200 x 900 mm (98 x 48 x 36 in)

2500 x 1600 x 1000 mm (98 x 63 x 40 in)

WEIGHT

5.5 kg (12.13 lb)

5.5 kg (12.13 lb)

OVERALL DIMENSIONS (TYPICAL VALUE)

259 x 152 x 175mm (11 x 6 x 6.9 in)

260 x 152 x 175mm (11 x 6 x 6.9 in)

MOUNTING DIMENSIONS
(TYPICAL VALUE)

340 x 182 x 281mm (13.39 x 7.15 x 11.07 in)

341 x 182 x 281mm (13.39 x 7.15 x 11.07 in)

TEMPERATURE RANGE

-10°C - 50 °C (14 - 122 °F)

-10°C - 50 °C (14 - 122 °F)

VOLTAGE SUPPLY/POWER
CONSUMPTION

24 VDC; 19 -75 W

25 VDC; 19 -75 W

IP RATING

IP65

IP65

EMBEDDED COMMUNICATION
INTERFACES

Ethernet (TCP/IP), RS232 / RS422

Ethernet (TCP/IP), RS232 / RS423

DIGITAL INPUTS/OUTPUTS

(1) Tachometer, (1) Trigger, (2) SW programmable general purpose

(1) Tachometer, (1) Trigger, (2) SW programmable general purpose

OPTIONS

Side-by-side package detection, irregulars, out-of-gauge detection

Side-by-side package detection, irregulars, out-of-gauge detection

COMPLIANCES

UL, cUL, FCC (Class A) CE

UL, cUL, FCC (Class A) CE

ETHERNET

YES

YES

CERTIFICATION

NCWM/NTEP Certified, OIML/MID, Measurement Canada

NCWM/NTEP Certified, OIML/MID, Measurement Canada

DEVICE PROGRAMMING

On board HTML web server interface

On board HTML web server interface

SC4000



The SC4000 is an industrial controller designed for high speed data collection in an ID-NET™ network of Datalogic's 1D and 2D bar code readers. The SC4000 offers high communication performance and connectivity to the most common fieldbus systems through a complete range of module.

FEATURES & BENEFITS

- Open architecture allows connectivity to Ethernet TCP/IP, PROFIBUS, DeviceNet Ethernet/ IP and other common networks
- Complete network monitoring, statistics and diagnostics through optional WebSentinel™ PLUS software
- Multi-language display and keypad for network monitoring
- Embedded Backup and Restore feature
- Visible LED indicators and Power on/off switch
- Multi-language Genius™ configuration tool

SC5000



SC5000 is a high performance industrial controller for omnidirectional and multi-side reading tunnels. It enables easy installation of complex tunnels with the ability to integrate laser devices, imagers and dimensioners. Installation and setup are pretty smooth processes thanks to enhanced internal connectivity for device synchronization EBC. Specialized connectors helps to avoid any human mistake about cabling the system and e-GENIUS, the web-based user interface, enables users to manage the configuration by all the popular web-browsers and OS. The controller provides all the needed tools for a quick maintenance of a reading tunnel, monitoring performance and system health in real-time.

FEATURES & BENEFITS

- Industrial controller for multi-side reading stations
- e-GENIUS™ web-based user interface
- Display and 5-key keypad for diagnostics and statistics
- Rugged industrial housing
- Ultralight and compact design
- Built-in Ethernet, Ethernet/IP and native Profibus and Profinet models
- Enables management of systems redundancy and fast scanner replacement in cases of failure
- Ethernet Bus Connections (EBC) for high speed data transmission and real time synchronization

CBX100



The CBX100 and CBX500, part of the CBX series, are a connectivity devices designed to simplify and speed-up cabling operations during the installation of Datalogic Industrial Automation devices. The CBX100's modular concept and complete range of module options make installation, configuration and maintenance faster than ever.

FEATURES & BENEFITS

- Flexible mounting and simplified wiring to speed up installation
- Reliable Backup and Restore features
- Open architecture allows connectivity to Ethernet TCP/IP, PROFIBUS, DeviceNet Ethernet/ IP and other common networks
- Multilanguage display for easy monitoring and troubleshooting
- Visible led indicators and power on/off switch

CONNECTIVITY



SC4000

SC5000

CBX100

	SC4000	SC5000	CBX100
DIMENSIONS (TYPICAL VALUE)	193 x 180 x 71 mm (7.6 x 7.09 x 2.8 in)	192 x 157 x 74 mm (7.57 x 6.18 x 2.91 in)	128 x 138 x 62 mm (5.04 x 5.43 x 2.44 in)
WEIGHT	960 g (33.86 oz)	1.5 kg (3.31 lb)	380g (13.40 oz)
VOLTAGE SUPPLY	10 to 30 VDC	10 to 30 Vdc (typ. 24 Vdc)	10 to 30 VDC
POWER CONSUMPTION OR CURRENT ABSORPTION	5 W max	0.5 A Max.	2.5 W max
OPERATING TEMPERATURE	0 to 50 °C (32 to 122 °F)	0° to +50 °C (+32° to +122 °F)	0 to 50 °C (32 to 122 °F)
PROTECTION CLASS	IP65	IP65	IP65
DISPLAY & KEYPAD	20 x 4 characters & 3 keys	20 x 4 characters & 5 keys	20 x 4 characters & 3 keys
EMBEDDED COMMUNICATION INTERFACES	Auxiliary: RS232 up to 115.2 Kbit/s Host Interface 1: RS232/RS485 up to 115.2 Kbit/s Host Interface 2: RS232/RS485 up to 115.2 Kbit/s ID-NET™ port up to 1 Mbps Optional Host Interface modules	"Communication interfaces: RS232 up to 115.2 Kbit/s RS422 full-duplex up to 115.2 Kbit/s, Serial Aux: RS232 up to 115.2 kbit/s, Ethernet (x2) TCP/IP, EBC (Ethernet Bus Connection)"	NO
COMMUNICATION PROTOCOL	Datalogic Application Driver (DAD Driver)	Datalogic Application Driver (DAD)	Datalogic Application Driver (DAD Driver)
DIGITAL INPUTS	Two SW programmable, optocoupled and polarity insensitive	3 polarity insensitive optocoupled inputs: Trigger, Encoder/Tachometer, IN3	Input 1(External Trigger) Input 2 Opto-coupled and polarity insensitive
DIGITAL OUTPUTS	Three SW programmable optocoupled	3 optocoupled outputs	Output 1 and Output 2 Opto-coupled
DEVICE PROGRAMMING	Genius™ (Windows™ based) SW Serial Host Mode Programming sequences	e-Genius	HW Switches, Genius™, DL.CODE
COMPATIBLE DEVICES	DS2100N, DS2400N, DS4800, Matrix 210N™, Matrix 300N™, Matrix 410N™, Matrix 450N™	Compatible with DS8110, DX8210, DM3610 dimensioners and hybrid integration with AV7000/NVS9000	DS2100N, DS2400N, DS4800, DS6300, DS6400, DX6400, DS8100A, DX8200A, DM3610, MATRIX 210N™, MATRIX 300N™, MATRIX 410N™, MATRIX 450N™

CBX500



The CBX100 and CBX500, part of the CBX series, are connectivity devices designed to simplify and speed-up cabling operations during the installation of Datalogic Automation devices. The CBX100's modular concept and complete range of module options make installation, configuration and maintenance faster than ever.

FEATURES & BENEFITS

- Flexible mounting and simplified wiring to speed up installation
- Reliable Backup and Restore features
- Open architecture allows connectivity to Ethernet TCP/IP, PROFIBUS, DeviceNet Ethernet/ IP and other common networks
- Multilanguage display for easy monitoring and troubleshooting
- Visible led indicators and power on/off switch

CBX510



The CBX510, part of the CBX series, is a connectivity device designed to simplify and speed-up cabling operations during the installation of Datalogic Industrial Automation devices. The CBX510's modular concept and complete range of module options make installation, configuration and maintenance faster than ever.

FEATURES & BENEFITS

- Flexible mounting and simplified wiring to speed up installation
- Reliable Backup and Restore features
- Open architecture allows connectivity to Ethernet TCP/IP, PROFIBUS, DeviceNet Ethernet/ IP and other common networks
- Visible led indicators and power on/off switch

CBX800



The CBX800 industrial connectivity device serves as a gateway, connecting devices equipped with a standard RS232 communication interface to the most common fieldbus systems, through a complete range of option module options, in addition to an ID-NET™ high speed communication network.

FEATURES & BENEFITS

- Serial to Fieldbus / Ethernet TCP/IP/ID-NET™ industrial gateway
- Open architecture provides interface to Ethernet TCP/IP, PROFIBUS, DeviceNet Ethernet/IP and other common networks
- Visible led indicators and power on/off switch
- Multilanguage Genius™ configuration tool
- Flexible mounting and simplified wiring to speed up installation

QL500-QLM500/600/700



The Quick Link series, available in 5 different models, is a complete range of accessories for connectivity dedicated to 1D and 2D bar code readers. Quick Link accessories offer an easy, fast, modular and cost-effective solution for the applications where "plug-in" connection is preferable.

FEATURES & BENEFITS

- Easy, fast, modular connection for ID-NET™ Network
- Distribution on separate connectors of Power Supply, External Trigger, ID-NET™ network, Digital I/O and Communication signals
- Serial-to-Ethernet TCP/IP protocol conversion through QL500 module.
- Cost effective solution
- Compact dimensions

APPLICATIONS

- Manufacturing
- Shop Floor
- Warehousing

CONNECTIVITY



CBX500

CBX510

CBX800

QL-QLM

DIMENSIONS (TYPICAL VALUE)

193 x 180 x 71 mm
(7.6 x 7.09 x 2.8 in)

193 x 180 x 71 mm
(7.6 x 7.1 x 2.8 in.)

193 x 180 x 71 mm (7.6 x 7.09 x
2.8 in)

QL300: 129x76x27 mm
(5.08 x 2.99 x 1.06 in)
QLM500/600/700: 200x81x40 mm
(7.87x3.19x1.57 in)

WEIGHT

780g (27.51 oz)

800 g. (28.25 oz.)

830g (29.28 oz)

QL300: 312g (11 oz)
QLM: 500g (17.64 oz)

VOLTAGE SUPPLY

10 to 30 VDC

10 to 30 Vdc

10 to 30 VDC

10 to 30 VDC

POWER CONSUMPTION OR
CURRENT ABSORPTION

2.5 W max

0.5 A max

2.5 W max

4 A max

OPERATING TEMPERATURE

0 to 50 °C (32 to 122 °F)

0° to 50 C (+32° to 122 °F)

0 to 50 °C (32 to 122 °F)

0 to 50 °C (32 to 122 °F)

PROTECTION CLASS

IP65

IP65

IP65

IP65

DISPLAY & KEYPAD

20 x 4 characters & 3 keys

NO

NO

NO

EMBEDDED
COMMUNICATION INTERFACES

YES

NO

Auxiliary: RS232 up to 115.2 Kbit/s
Data Source: RS232 up to 115.2
Kbit/s
Host Interface: RS232/RS485 up to
115.2 Kbit/s
ID-NET™ port up to 1 Mbps
Optional Host Interface modules

Ethernet, EtherNet/IP, Profibus,
PROFINET (depending on model)

COMMUNICATION PROTOCOL

Datalogic Application Driver (DAD
Driver)

NO

Datalogic Application Driver (DAD
Driver)

NO

DIGITAL INPUTS

Input 1(External Trigger)
Input 2 Opto-coupled and polarity
insensitive

Input 1(External Trigger),
Input 2 and Input 3 opto-coupled
and polarity insensitive

Input 1(External Trigger)
Input 2 Opto-coupled and polarity
insensitive

Input 1(External Trigger)

DIGITAL OUTPUTS

Output 1 and Output 2 Opto-
coupled

Output 1 and Output 2 Opto-
coupled

Output 1, Output 2 and Output 3
Opto-coupled

N° 1 I/O

DEVICE PROGRAMMING

HW Switches, Genius™,
DL.CODE™

e-Genius

Genius™ (Windows™ based) SW
Serial Host Mode Programming
sequences

HW Switches, Genius™,
DL.CODE™

COMPATIBLE DEVICES

DS2100N, DS2400N, DS4800,
Matrix210N, Matrix300N,
Matrix410N, Matrix450N

DS8110, DX8210, DM3610-2
head, SC5000

(including 3rd Party)

DS2100N, DS2400N, DS4800,
Matrix 210N™, Matrix 300N™,
Matrix 410N™, Matrix 450N™



BSR idware GmbH
Jakob-Haringer-Str.3
A-5020 Salzburg
Web: www.bsr.at

HEADQUARTERS

DATALOGIC AUTOMATION SRL

Via Lavino, 265
40050 Monte San Pietro - Bologna - Italy
Tel: +39 051/6765611
info.automation.it@datalogic.com

BRANCHES AND SALES OFFICES

EUROPE

BENELUX

DATALOGIC AUTOMATION BENELUX

Newtonweg 3
4104 BK Culemborg - The Netherlands
Tel. +31 345/589489
info.automation.nl@datalogic.com

FRANCE

DATALOGIC AUTOMATION SRL

Succursale en France
Le Parc Technologique de Lyon
333 cours du 3ème Millénaire - Le Pôle
69800 Saint Priest
Tél. +33 (0)4/72476180
info.automation.fr@datalogic.com

GERMANY

DATALOGIC AUTOMATION SRL

Niederlassung Central Europe
Gottlieb-Stoll-Straße 1,
73271 Holzmaden
Tel. +49 7023 7453-100
info.automation.de@datalogic.com

ITALY

DATALOGIC AUTOMATION ITALY

Via Lavino, 265
40050 Monte San Pietro - Bologna
Tel. +39 051/6765611
info.automation.it@datalogic.com

Via Taormina 1
20093 - Cologno Monzese (MI) Italy
Tel. +39 02 25151211
info.automation.it@datalogic.com

Via Le Gorrey, 10 11020, Donnas - Aosta
Tel. +39-0125-8128201
info.automation.it@datalogic.com

SPAIN

DATALOGIC AUTOMATION IBERIA

Sucursal en España
C/ Frederic Mompou 4 esc A, 4º puerta 3ª
08960 Sant Just Desvern - Barcelona
Tel. +34 (0)93/4772059

NORDIC

DATALOGIC AUTOMATION AB

Höjdrodergatan 21
21239 Malmö - Sweden
Tel. +46 (0)40/385000
info.automation.se@datalogic.com

UNITED KINGDOM

DATALOGIC AUTOMATION UK

Datalogic House
Dunstable Road, Redbourn - Herfordshire
AL3 7PR
Tel. +44 (0) 1582 791750
info.automation.uk@datalogic.com

TURKEY

Datalogic ADC Turkey

Merkezi Italya Istanbul Merkez Şubesi Süleyman
Seba Cad. No:48 BJK Plaza A. Blok Kat:4 D.44
34357 - Istanbul - Turkey
Tel. +90 212 396 1550
info.adc.tr@datalogic.com

NORTH AMERICA

DATALOGIC AUTOMATION INC

511 School House Road
Telford, PA 18969-1196 - United States
Tel. +1-800-BAR-CODE or +1-215-723-0981
info.automation.us@datalogic.com

DATALOGIC AUTOMATION INC

MACHINE VISION
5775 W Old Shakopee Rd
STE 160, Bloomington, MN 55437
United States
Tel. +1-952-996-9500
info.automation.us@datalogic.com

SOUTH AMERICA

Datalogic Brazil

Avenida Olivio Roncoletta, 465
Bairro Vila Hortolandia Jundiá (SP), Brazil
Tel. +55 11 29232600
info.automation.br@datalogic.com

APAC

Australia-New Zealand

DATALOGIC AUTOMATION PTY LTD

Unit 130, 45 Gilby Road
Mt Waverley - Victoria, 3149 - Australia
Tel. +61 (0)3/95589299
info.automation.au@datalogic.com

CHINA

DATALOGIC AUTOMATION ASIA

2nd Floor, 10 Building, Dayuan Industrial Zone,
No.1, Pingshan 1st Road,
Liuxuan Blvd. Xili, Nanshan District,
518054, Shenzhen, China
Tel: +86 (0)755-8629 6779
info.automation.cn@datalogic.com

R206, 2F, No. 1288 Longdong Avenue,
Pudong New Area,
Shanghai, 201203
Tel: +86 (0)21-5836 6692
info.automation.cn@datalogic.com

Floor 20, Room 2019, Building 2,
16 West Nan San Huan Road
Fengtai District, Beijing
Tel: +86 (0)10-8757 6375
info.automation.cn@datalogic.com

1202, Excellence Build, 128 Yanji Road,
Shibe District, Qingdao, China
Tel: +86 (0)532 55787889

JAPAN

IDEC AUTO-ID SOLUTIONS CORPORATION

8-10, Shioe 5-chome, Amagasaki Hyogo,
Japan 661-0976
Tel. +81-6-7711-8880
www.idec.com

Rev. 03, 11/2016



9C514400E

Product and Company names and logos referenced may be either trademarks or registered trademarks of their respective companies. We reserve the right to make modifications and improvements.



DATALOGIC
THE VISION IS YOURS

www.datalogic.com